



MGS-550

Fixed Gas Detector

User Manual

Installation • Operation • Configuration • Troubleshooting

P/N: 1100-1000
August 21, 2015
Version 0



Product Leadership • Training • Service • Reliability

WARRANTY POLICY

Bacharach, Inc. warrants this instrument, excluding sensors, to be free from defects in materials and workmanship for a period of two years from the date of purchase by the original owner. The sensors have a pro-rated warranty period of 6 to 18 months, depending on the sensor type. If the product should become defective within this warranty period, we will repair or replace it at our discretion.

The warranty status may be affected if the instrument has not been used and maintained per the instructions in this manual or has been abused, damaged, or modified in any way. This instrument is only to be used for purposes stated herein. The manufacturer is not liable for auxiliary interfaced equipment or consequential damage.

Due to ongoing research, development, and product testing, the manufacturer reserves the right to change specifications without notice. The information contained herein is based on data considered accurate. However, no warranty is expressed or implied regarding the accuracy of this data.

All goods must be shipped to the manufacturer by prepaid freight. All returned goods must be pre-authorized by obtaining a return merchandise authorization (RMA) number. Contact the manufacturer for a number and procedures required for product transport.

SERVICE POLICY

Bacharach, Inc. maintains an instrument service facility at the factory. Some Bacharach distributors/agents may also have repair facilities; however, Bacharach assumes no liability for service performed by anyone other than Bacharach personnel. Repairs are warranted for 90 days after date of shipment (sensors, pumps, filters and batteries have individual warranties). Should your instrument require non-warranty repair, you may contact the distributor from whom it was purchased or you may contact Bacharach directly.

If Bacharach is to do the repair work, send the instrument, prepaid, to the closest Service Center.

Service Location	Service Contact Information	Service Shipping Address
United States	http://mybacharach.com/rmaform/ Phone: +1 724 334 5000 Toll Free: 1 800 736 4666 Fax: +1 724 334 5001 Email: help@MyBacharach.com	Bacharach, Inc. 621 Hunt Valley Circle New Kensington, PA 15068, USA ATTN: Service Department
Ireland	Phone: +353 1 284 6388 Fax: +353 1 284 6389 Email: ask@Murco.ie	Murco – A Bacharach Company 114A Georges Street Lower Dun Laoghaire, Dublin, Ireland ATTN: Service Department
Canada	Phone: +1 905 470 8985 Fax: +1 905 470 8963 Email: support@BachCan.ca	Bacharach of Canada 20 Amber Street Unit #7 Markham, Ontario L3R 5P4, Canada ATTN: Service Department

Always include your RMA #, address, telephone number, contact name, shipping/billing information and a description of the defect as you perceive it. You will be contacted with a cost estimate for expected repairs prior to the performance of any service work. For liability reasons, Bacharach has a policy of performing all needed repairs to restore the instrument to full operating condition.

Prior to shipping equipment to Bacharach, contact our office for an RMA # (returned merchandise authorization). All returned goods **must** be accompanied with an RMA number.

Pack the equipment well (in its original packing if possible), as Bacharach cannot be held responsible for any damage incurred during shipping to our facility.

NOTICES

This manual is subject to copyright protection; all rights are reserved under international and domestic copyright laws. This manual may not be copied or translated, in whole or in part, in any manner or format, without the written permission of Bacharach, Inc.

All software utilized and/or distributed by Bacharach is subject to copyright protection. All rights are reserved. No party may use or copy such software in any manner or format, except to the extent that Bacharach grants them a license to do so. If this software is being loaded onto more than one computer, extra software licenses must be purchased.

TABLE OF CONTENTS





SECTION 1. SAFETY	5
1.1 Definition of Alert Icons.....	5
1.2 General Safety Statements	5
1.3 Safe Connection of Electrical Devices	5
SECTION 2. DESCRIPTION.....	6
2.1 Product Overview	6
2.2 Key Product Features	7
2.3 General Purpose Option.....	8
2.4 Explosion Proof Option	9
2.5 Sensor Styles.....	10
SECTION 3. INSTALLATION.....	11
3.1 General Information for Installation	11
3.2 Installation Restrictions.....	11
3.3 Mechanical Installation	12
3.4 Electrical Installation	12
3.4.1 Preparations	12
3.4.2 Power and Signal Wiring	14
3.4.3 Relay Wiring	15
3.4.4 Installation of Remote Sensing Head	16
3.4.5 Connecting One or More MGS-550s to a Bacharach Controller.....	17
3.4.6 Modbus RTU Interface	17
3.4.7 Conclusion.....	17
SECTION 4. OPERATION.....	18
4.1 Overview of Normal Operation	18
4.1.1 Applying Power and the Start-up Sequence	18
4.1.2 Verifying Analog Signals.....	19
4.1.3 Verifying the Digital Modbus Signal.....	19
4.1.4 The 5-Digit Display and LEDs	19
4.2 Menus.....	21
4.2.1 General Navigation.....	21
4.2.2 Checking Status and Changing Parameter Values.....	22
4.2.3 Exiting the Menu.....	22
4.2.4 Menu Overview.....	23
4.3 Functions	25
4.3.1 Offline Mode (F-01)	25
4.3.2 Zero Adjustment (F-02)	25
4.3.3 Span Adjustment (F-03)	25
4.3.4 Instrument Test (F-04).....	25
4.3.5 Parameter Menu (F-05).....	26
4.3.6 Register Sensor (F-06).....	26
4.3.7 De-register One Sensor (F-07).....	27
4.3.8 De-register All Sensors and Reset Node Address (F-08)	27
4.3.9 Diagnostics, System Information and Fault Data (F-09)	28
4.3.10 Reset System to Factory Default Setting (F-10)	28
4.4 Parameters	29
4.4.1 Sensor 1 Settings (S1-xx) and Sensor 2 Settings (S2-xx) if Connected.....	29
4.4.2 Relay Designation (RX-xx)	32
4.4.3 Alarm Configuration (AF-xx).....	33
4.4.4 Analog Output Configuration (AX-xx)	34
4.4.5 Modbus Configuration (MB-xx).....	35
4.4.6 Display Mode (P1-01).....	35
4.4.7 Buzzer Designation (B1-xx).....	35
SECTION 5. MAINTENANCE.....	36
5.1 Maintenance Intervals	36

5.2	Making Adjustments to Sensors	36
5.2.1	Introduction	36
5.2.2	General Procedure	37
5.2.3	Zero Adjustment	38
5.2.4	Span Adjustment	38
5.2.5	System Bump Test	38
5.3	Troubleshooting	39
5.3.1	Hexadecimal Format	39
5.3.2	Diagnostics Attributes	39
5.3.3	Instrument Electronics Critical (E100) Faults	41
5.3.4	Non-Critical (E300) Faults	42
5.3.5	Sensor Faults	42
5.4	Sensor Maintenance (General Purpose Housings)	44
5.4.1	Components Overview	44
5.4.2	Replacing the Sensor Module	45
5.4.3	Replacing the Sensor Control Board	46
5.4.4	Replacing the Local Sensing Head Assembly	47
5.4.5	Adding a Second Sensor	48
5.4.6	Replacing the Remote Sensing Head Assembly	49
5.5	Sensor Maintenance (Explosion Proof Housings)	50
5.5.1	Components Overview	50
5.5.2	Replacing the Sensor Module	51
5.5.3	Replacing the Sensor Control Board	52
5.5.4	Replacing the Local Sensing Head Assembly	53
5.5.5	Replacing the Remote Sensing Head Assembly	54
5.6	Replacing the Instrument Electronics	55
5.7	Replacing the Interface Board	56
5.8	Cleaning the Instrument	56
SECTION 6.	FACTORY DEFAULT SETTINGS	57
SECTION 7.	SENSOR PRINCIPLE	59
7.1	Electrochemical Sensors	59
7.2	Catalytic Bead Sensors	59
7.3	Semiconductor Sensors	59
7.4	Infrared Sensors	60
SECTION 8.	DISPOSING OF THE INSTRUMENT	61
8.1	Disposing of Electrical and Electronic Equipment	61
8.2	Disposing of Electrochemical Sensors	61
SECTION 9.	TECHNICAL DATA	62
9.1	General Specifications	62
9.2	Sensor Specifications	63
9.3	Modbus Registers	64
9.3.1	Analog Input Registers	65
9.3.2	Analog Output Registers	67
9.3.3	Input Status Flags	69
9.3.4	Output Status Flags	70
SECTION 10.	ORDERING INFORMATION	72
10.1	MGS-550 Instrument Only	72
10.2	MGS-550 Gas Detector, IP66 with IP66 Sensor	72
10.3	MGS-550 Ex d Instruments with Sensing Heads	74
10.4	MGS-550 Gas Detector, Ex d Enclosure with Ex d Sensing Head	74
10.5	MGS-550 5m Remote and Second Sensing Heads	76
10.6	MGS-550 Replacement Parts and Accessories	78
SECTION 11.	DECLARATION OF CONFORMITY	79

SECTION 1. SAFETY

1.1 Definition of Alert Icons

The following alert icons are used in this document to highlight areas of the associated text that require a greater awareness by the user.

Alert	Icon	Description
DANGER		Indicates an imminently hazardous situation which, if not avoided, will result in death or serious injury.
WARNING		Indicates a potentially hazardous situation which, if not avoided, could result in death or serious injury.
CAUTION		Indicates a potentially hazardous situation which, if not avoided, could result in physical injury or damage to the product or environment. It may also be used to alert against unsafe practices.
NOTICE		Indicates additional information on how to use the product.

1.2 General Safety Statements

- Before using this product, carefully read and strictly follow the instructions in the manual.
- Use the product only for the purposes specified in this document and under the conditions listed.
- Ensure that product documentation is retained, made available, and appropriately used by anyone operating the product.
- Comply with all local and national laws, rules, and regulations associated with this product.
- Only trained and competent personnel may use this product.
- Only trained and competent personnel may inspect, repair and maintain the product as detailed in this manual. Maintenance that is not detailed in this manual must be completed by Bacharach or personnel qualified by Bacharach.
- Use only genuine Bacharach spare parts and accessories. Otherwise, operation may be impaired.
- Only operate the product within the framework of a risk-based alarm signaling concept.

1.3 Safe Connection of Electrical Devices

- Before connecting this instrument to electrical devices not mentioned in this manual, consult the manufacturer or a qualified professional.

SECTION 2. DESCRIPTION

2.1 Product Overview

The Bacharach MGS-550 continuously monitors indoor or outdoor ambient air for the following gases:

- toxic and combustible gases
- oxygen
- refrigerants.

The instrument is housed in one of the following:

- rugged ABS enclosure (general purpose or “GP” housing)
- aluminum enclosure (explosion-proof or “XP” housing).

The instrument can be connected to a Bacharach monitoring system or a Programmable Logic Controller (PLC). With the integrated alarm relay, the instrument can be operated as a stand-alone unit (with additional local alarm signaling). The instrument is designed to be installed in non-classified, non-hazardous, permanent locations.



WARNING

Danger of explosions. This product is neither certified nor approved to be operated in oxygen-enriched atmospheres.



WARNING

The device is not intended to be used in areas classified as hazardous.

2.2 Key Product Features

- Enclosure options:
 - General-purpose (GP): ABS plastic housing (rectangular)
 - Explosion-proof (XP): Aluminum housing (round)
- Power options (refer to section 9.1: General Specifications on page 62):
 - 24 VAC
 - 19.5 to 28.5 VDC
- Multi-function, 5-digit LED display
 - gas concentrations
 - status messages
 - menu choices
- Diagnostic/status LEDs (3)
- Configurable output signal (based on measured gas concentration):
 - Analog output 4 to 20 mA
 - Analog output 0 to 5 V
 - Analog output 0 to 10 V
 - Analog output 1 to 5 V
 - Analog output 2 to 10 V
 - Digital output Modbus RTU signal
- Independently configurable analog outputs (2)
- Redundant sensor mapping option (one sensor can be mapped to both analog outputs)
- Multi-wire signal transmission configurations:
 - Analog 1 sensor (2-wire)
 - Analog 2 sensors (3-wire or 4-wire)
 - Digital Modbus communications (2-wire plus ground)
- Menu navigation options:
 - Internal buttons to use if the cover is removed
 - Non-intrusive magnetic wand to use on external adjustments points on the cover
- Non-intrusive magnetic wand can be used to configure, calibrate, and maintain the device

2.3 General Purpose Option

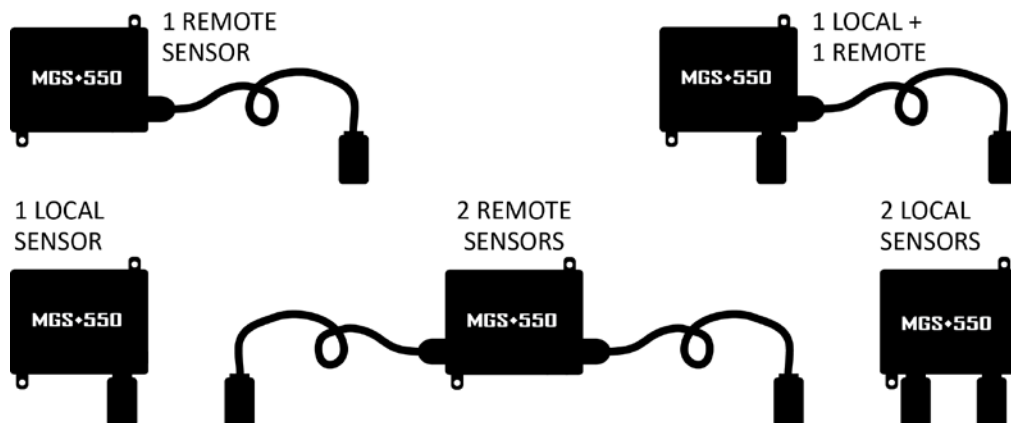
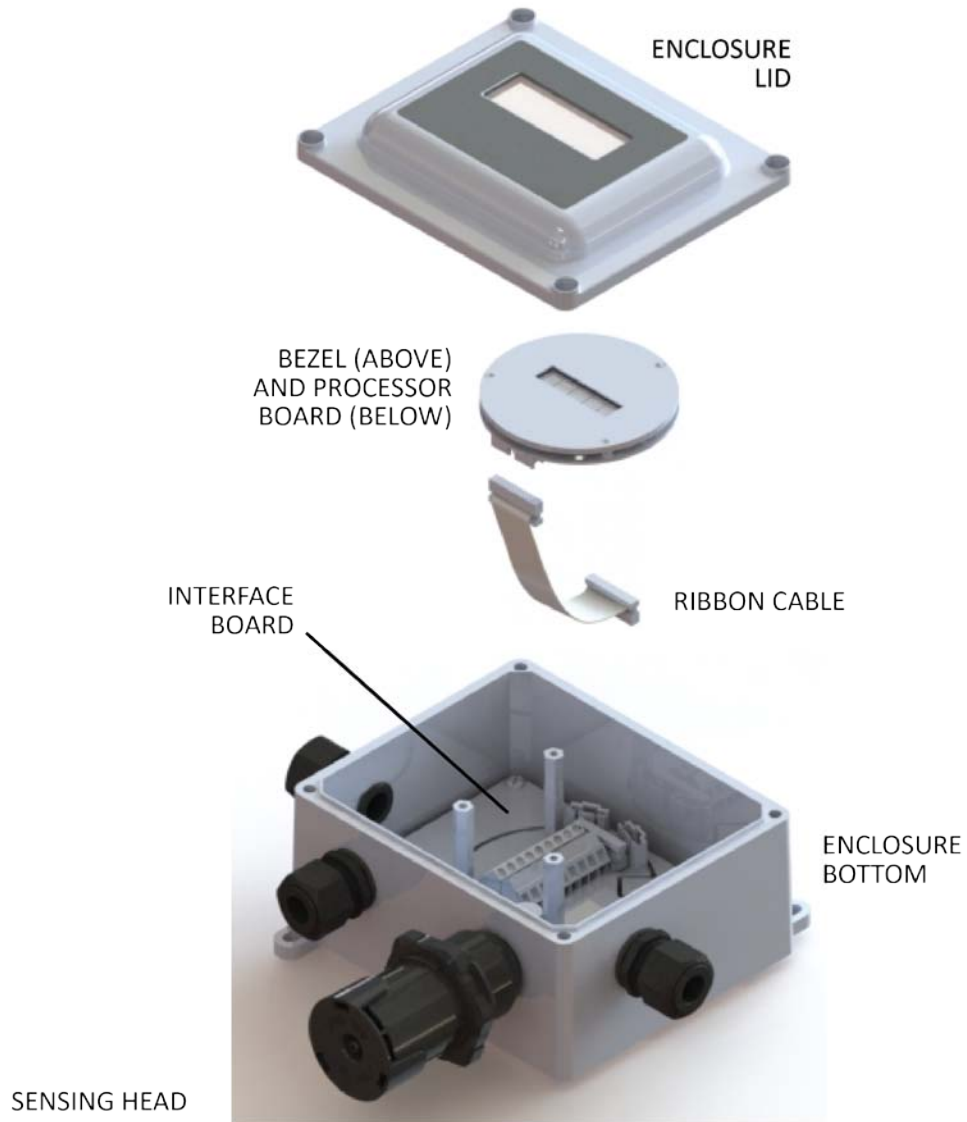

2.4 Explosion Proof Option

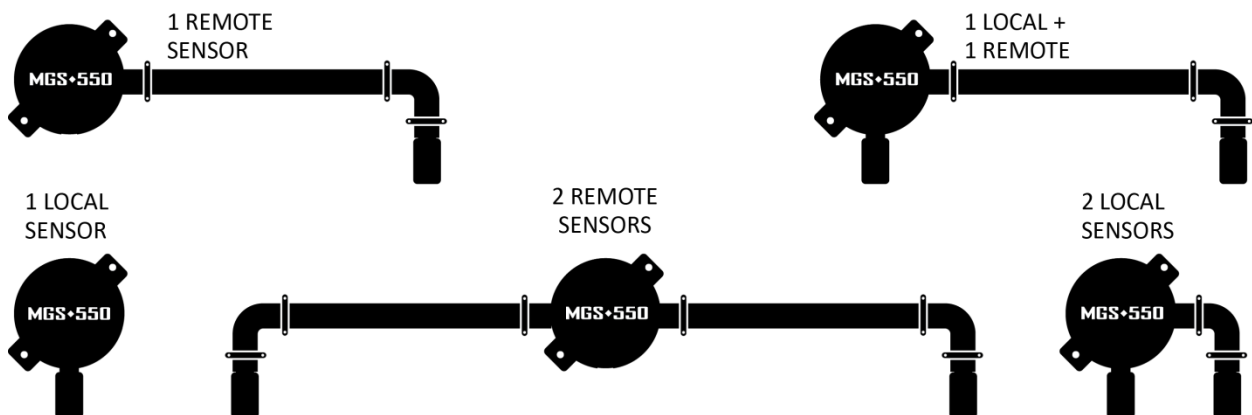
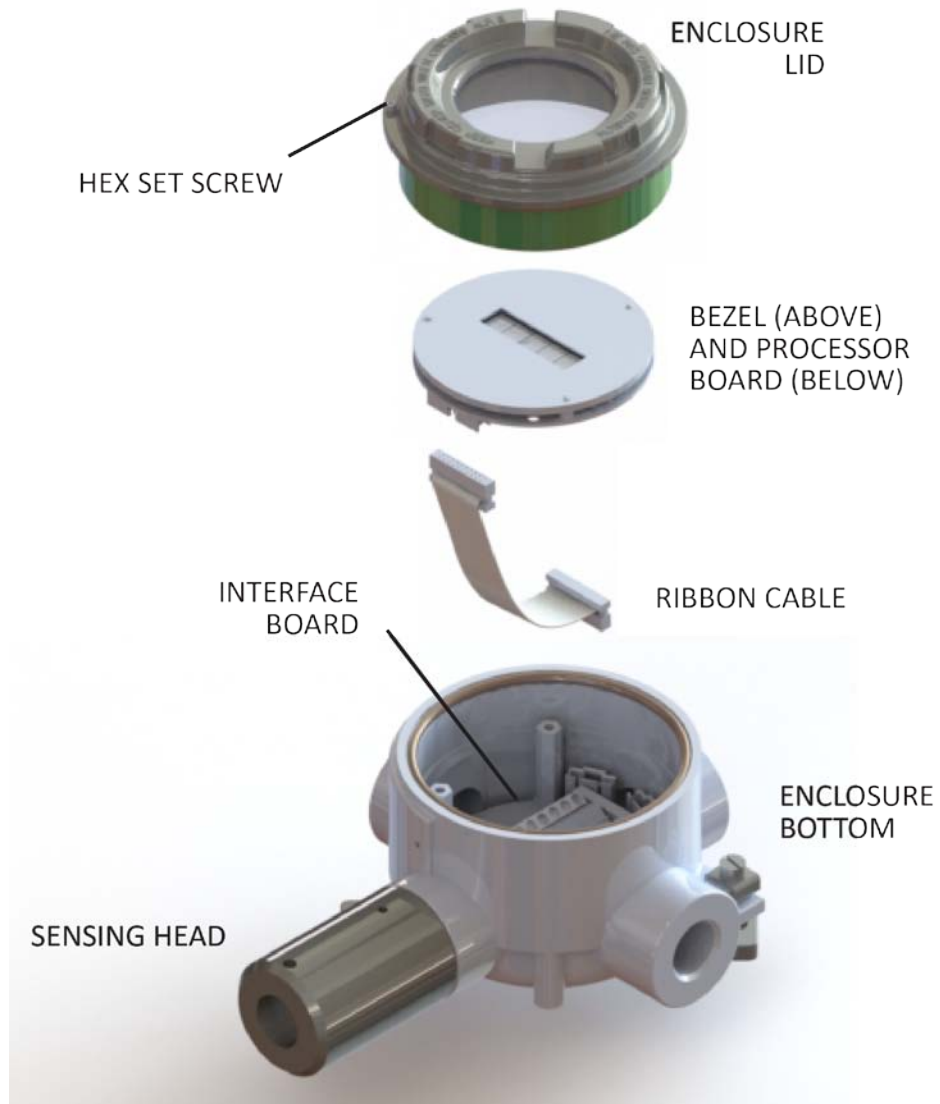

2.5 Sensor Styles

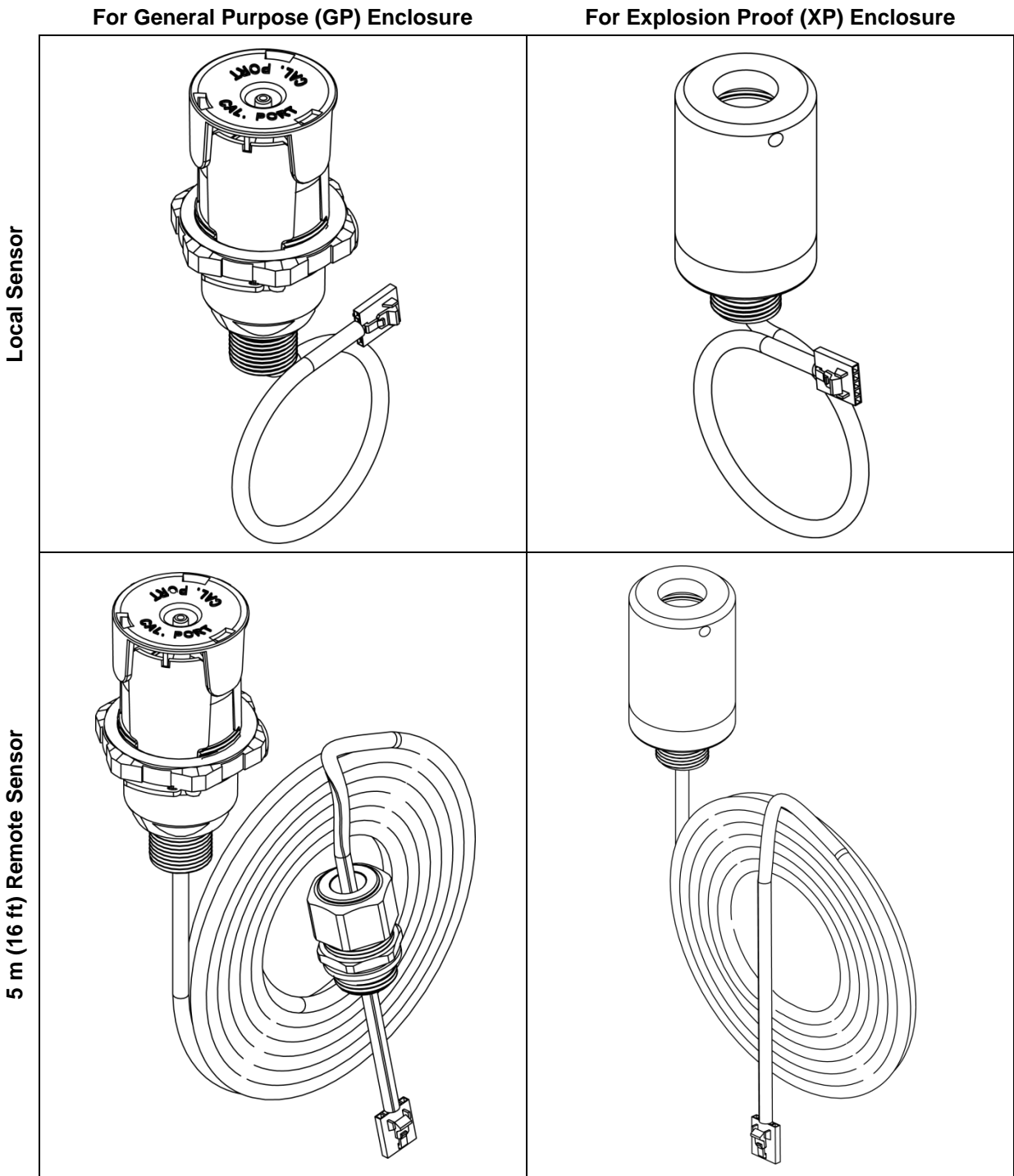

SECTION 3. INSTALLATION

3.1 General Information for Installation

Every detail of installation site selection is critical to ensure overall system performance and effectiveness. Strict compliance and considerable thought must be given to every detail of the installation process, including, but not limited to the following:

- Regulations as well as local, state, and national codes that govern the installation of gas monitoring equipment
- Electrical codes that govern the routing and connection of electrical power and signal cables to gas monitoring equipment
- The full range of environmental conditions to which the instruments will be exposed
- The physical characteristics of the gas or vapor to be detected
- The specifics of the application (e.g., possible leaks, air movement/draft, etc.)
- The degree of accessibility required for maintenance purposes
- The types of optional equipment and accessories that will be used with the system
- Any limiting factors or regulations that would affect system performance or installations
- Wiring details, including the following.
 - The general purpose enclosure provides four M20 x 1.5 mm openings, which can be used for field wiring, direct attachment of a sensor, or wiring of a remote sensor.
 - The explosion-proof enclosure provides four M20 x 1.5 mm openings, which can be used for field wiring, direct attachment of a sensor, or wiring of a remote sensor.
 - Unused openings must be closed with a suitable plug and gasket, maintaining the IP or Ex d rating.
 - Secondary circuit must be supplied from an isolating source (not applicable for relay circuits).
 - The wiring for the relays must be selected and fused according to the rated voltages, currents, and environmental conditions.
 - If stranded conductors are used, a ferrule should be used.
 - To improve RFI immunity in extreme environments, it might be necessary to ground the shield of the communications cable at the PLC, GDA controller, front-end controller, or Building Management System (e.g., the chassis, the ground bus-bar, etc.).

3.2 Installation Restrictions

- The installation location must have appropriate supply power available for the instrument (i.e., 19.5 to 28.5 VDC or 24 VAC). Refer to section 9: Technical Data on page 62. This ultimately determines the distance the instrument can be mounted from the controller or power supply.



WARNING

The MGS-550 must be powered by either:

- a suitable UL/CSA/IEC 60950 certified power supply that is isolated from line voltage by double insulation, or
- an appropriately rated UL listed/CSA/IEC Class 2 transformer.

- The instrument accepts wire sizes of 16 AWG (1.5 mm²) to 20 AWG (0.5 mm²).
- Depending on the configuration, use at least a shielded, multi-conductor cable.
- The instrument must not be exposed to radiant heat that will cause the temperature to rise beyond the limits stated in section 9: Technical Data on page 62. The use of a reflecting shield is recommended.
- The enclosure is weatherproof within environmental specifications and suitable for outdoor installation.
- Each instrument must be installed and operated in an environment that conforms to the specifications listed in section 9: Technical Data on page 62.

3.3 Mechanical Installation

- Select a mounting location that is accessible for maintenance and adjustment.
- Ensure that any targeted gas or vapor has unobstructed access to the sensor.
- Consider implications of the future use of accessories and maintenance equipment.
- Ensure that the mounting surface is flat and plumb.
- Use the drilling template for proper positioning (see Installation Guide P/N 1100-0999).
- Ensure that any installed sensor is pointing downwards.
- Bacharach recommends using M5 bolts (or smaller) with hex socket caps to mount the device.

3.4 Electrical Installation

3.4.1 Preparations



CAUTION

Ensure wiring for relays and connections for sensor(s) are made *before* applying power.



CAUTION

This product uses semiconductors which can be damaged by electrostatic discharge (ESD). When handling the printed circuit boards (PCBs), observe proper ESD precautions so that the electronics are not damaged.



NOTICE

For unused 4 to 20 mA analog outputs, ensure that the wire-bridge (pin 3 to 4 and pin 5 to 6) is installed. Otherwise, a fault may be displayed if the wiring does not match the configuration. The analog outputs are designed as sources.

- Open the enclosure lid. For the general purpose (GP) enclosure, loosen the four screws using an M5 hex key and remove the lid from the base. For the explosion proof (XP) enclosure, loosen the hex set-screw (1.5 mm hex key) and unscrew the lid from the instrument base.



- To access the Interface Board, use a flat-head screwdriver to loosen the three captive screws on the Processor Board. Access the captive screws through holes in the Display Bezel. Carefully pull out the bezel and Processor Board (as a single unit) from the enclosure. Note that a ribbon cable connects the Processor Board to the Interface Board.

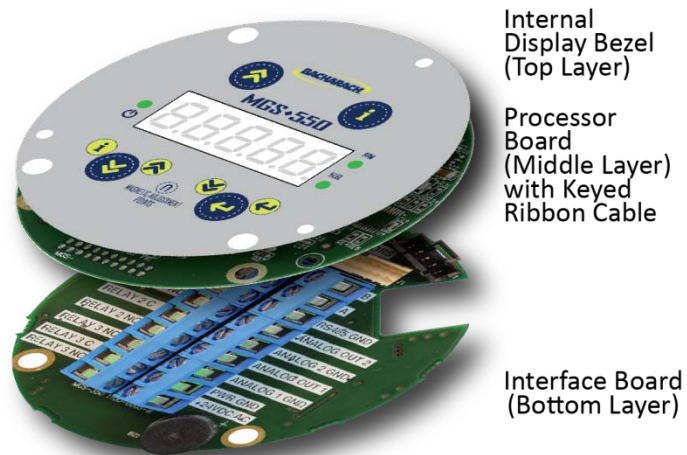
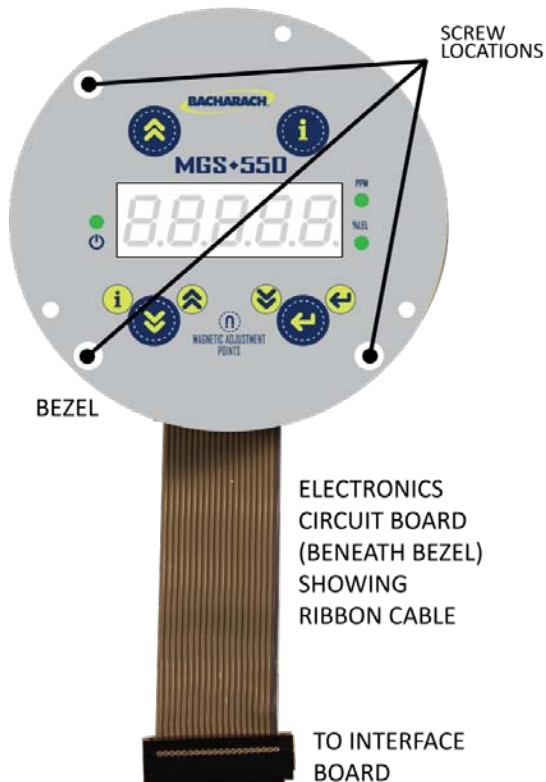
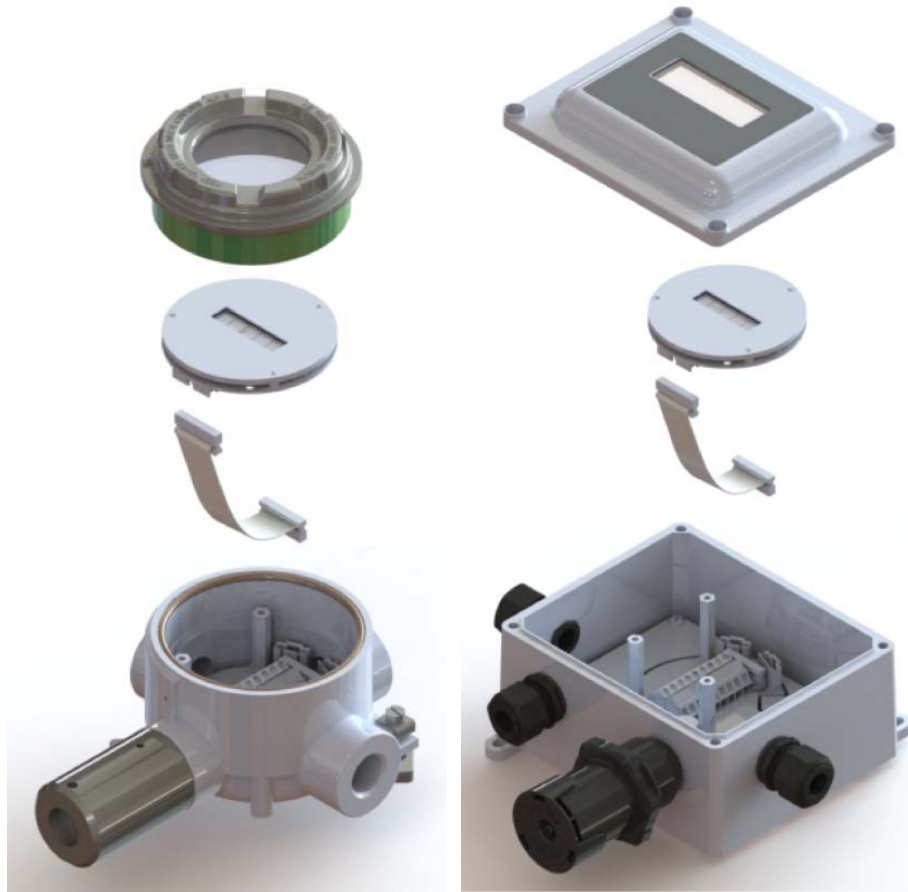

MGS-550 Fixed Gas Detector

3.4.2 Power and Signal Wiring

- Using appropriate cable glands and/or conduit, connect the wires for power and signal to the appropriate terminal as indicated in the figure and wiring table that follow.
- Polarity must not be reversed.
- For 24 VAC installations in a daisy-chain configuration, the neutral polarity must be maintained for all instruments.
- Fasten terminal screws.

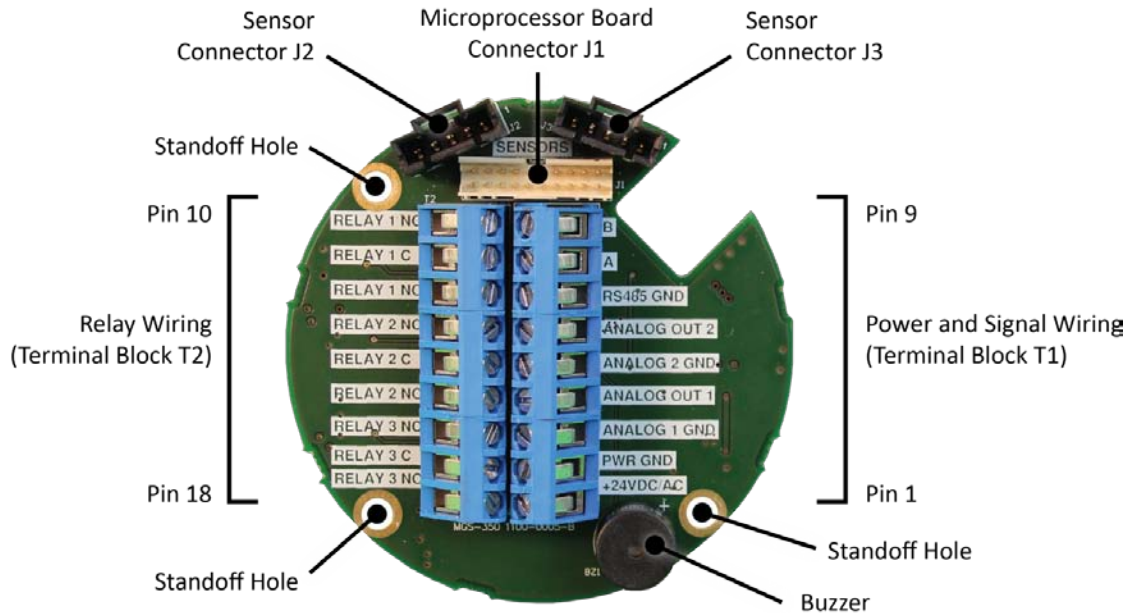

Connection	Description	Pin	Label	Wiring Termination
Power	24 VAC	1	+ 24VDC/AC	24 VAC line
		2	PWR GND	24 VAC neutral
	24 VDC*	1	+ 24VDC/AC	24 VDC positive
		2	PWR GND	24 VDC ground
Analog Output	Analog Output 1*	3	ANALOG 1 GND	Analog output 1 ground
		4	ANALOG OUT 1	Analog output 1 signal (+)
	Analog Output 2*	5	ANALOG 2 GND	Analog output 2 ground
		6	ANALOG OUT 2	Analog output 2 signal (+)
Digital Output	Modbus Network Communications	7	RS-485 GND	RS-485 shield
		8	A	RS-485 "A" (non-inverted)
		9	B	RS-485 "B" (inverted)

* For 3-wire, single-sensor DC installations: connect pins 1 and 2 of 24 VDC, and connect pin 4 to the analog input of the control system. For 4-wire, dual-sensor DC installations: connect pins 1 and 2 of 24 VDC, connect pin 4 to one analog input of the control system, and connect pin 5 to another input of the control system.

- If central monitoring or a PLC is used, connect the signal cable shielding at the controller only.
- If an analog output is *unused* and configured as a 4 to 20 mA output, then the corresponding output connectors must be shorted, otherwise a fault will occur. For unused analog output 1 configured as a 4 to 20 mA output, wire pin 3 to pin 4. For unused analog output 2 configured as a 4 to 20 mA output, wire pin 5 to pin 6. These jumper wires are installed at the factory, but should be removed for voltage outputs or if connections are made to the analog outputs.

3.4.3 Relay Wiring



WARNING

At voltages > 30 VAC or > 42.2 VDC, the relay cables must be enclosed in protective conduit, or double-insulated cables must be used.

- Using appropriate cable glands and/or conduit, connect the wires for relay 1, relay 2, and relay 3 to the terminals (see previous wiring figure) as indicated in the following wiring table. (Note that any one of 6 alarms or 3 fault types may be mapped to any relay.)

Function	Pin	Label	Wiring Termination
Relay 1 Output	10	RELAY 1 NC	Relay 1 NC contact
	11	RELAY 1 C	Relay 1 common contact
	12	RELAY 1 NO	Relay 1 NO contact
Relay 2 Output	13	RELAY 2 NC	Relay 2 NC contact
	14	RELAY 2 C	Relay 2 common contact
	15	RELAY 2 NO	Relay 2 NO contact
Relay 3 Output	16	RELAY 3 NC	Relay 3 NC contact
	17	RELAY 3 C	Relay 3 common contact
	18	RELAY 3 NO	Relay 3 NO contact

To change relay designations, see section 4.4.2: Relay Designation (RX-xx) on page 32. For default values, see section 6: Factory Default Settings on page 57.

When configured according to the factory default settings, the relays are de-energized during normal operation (not fail-safe). Fail-safe mode can be configured. See section 4.4.2: Relay Designation (RX-xx) on page 32. The terminal designators in the previous wiring table show factory defaults and normal operation mode.



NOTICE

To ensure that a fault is easily “recognized” (that is, without needing to look directly at the instrument’s display), one relay should be designated for instrument faults and an alarm device should be connected to the fault relay.

3.4.4 Installation of Remote Sensing Head

- Remove a blind-plug from the enclosure (if applicable).
- Feed the connector of the sensor (see below, left) through a cable gland or conduit (if applicable), through the opening of the enclosure, and then into the enclosure.
- Secure the cable gland (with attached gasket) or appropriate conduit into the housing in order to maintain IP or Ex d rating.



- Plug the sensor connector into the socket until the lock engages. For a new instrument with no sensor connected, it does not matter which socket is used first. However, if a sensor is already connected, then it should be left plugged into its socket.
- If two remote sensors are to be installed, register only one sensor at a time. Refer to section 4.3.6: Register Sensor (F-06) on page 26.

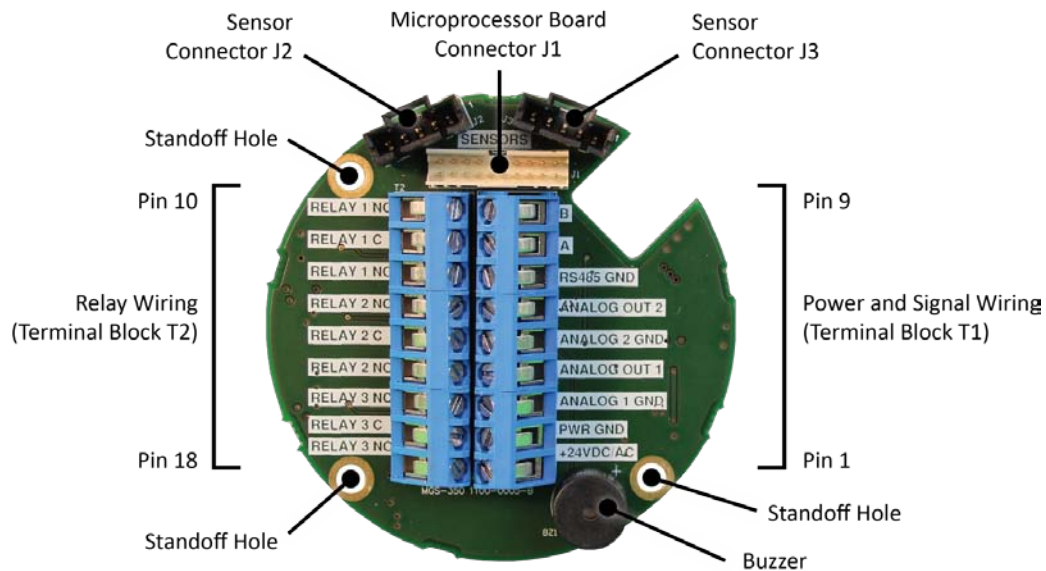

NOTICE

A sensor is automatically recognized and registered by the instrument after a power cycle. Alternatively, function F-06 can be used to register a sensor without a power cycle. See section 4.3.6: Register Sensor (F-06) on page 26, section 4.3.7: De-register One Sensor (F-07) on page 27, and section 4.3.8: De-register All Sensors and Reset Node Address (F-08) on page 27.

3.4.5 Connecting One or More MGS-550s to a Bacharach Controller



For wiring and configuration information, please refer to the manual which was included with the Bacharach controller (e.g., MGS, GDA, etc.).

NOTICE

- At the central control system, connect the shield of the wires to the earth ground of the controller (e.g., the chassis, the ground bus-bar, etc.).
- For 24 VDC installations, the input is protected. If the polarity is reversed, the instrument will not power-up.
- For 24 VAC installations in daisy-chain, the neutral polarity must be maintained for all instruments (see example below).

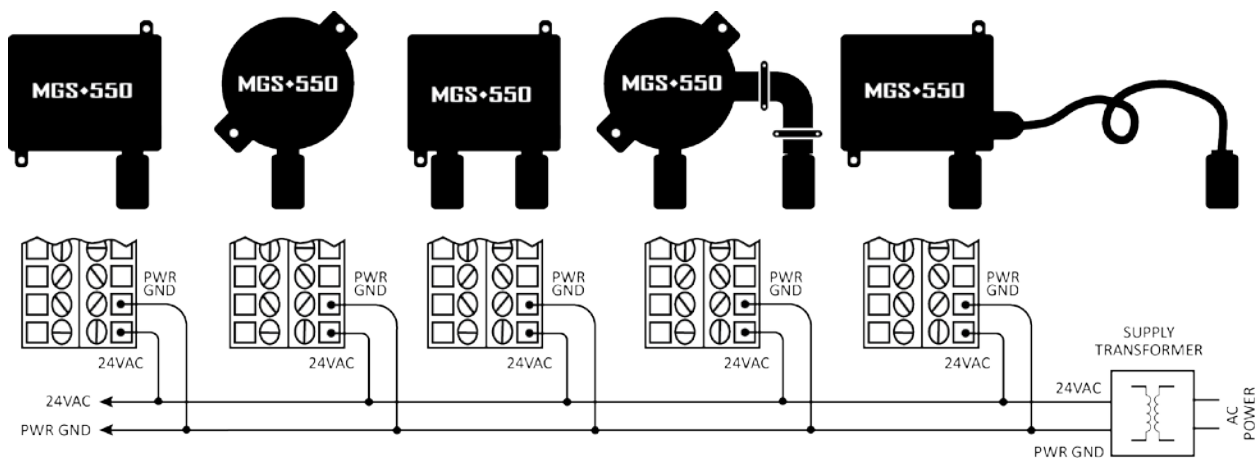

3.4.6 Modbus RTU Interface

- For the Modbus network use an 18 to 24 AWG (0.5 to 1 mm²) shielded twisted pair wire with a 120Ω characteristic impedance.
- The Modbus address, baud rate, stop bit, parity and slave termination is configured through the setup menu. No jumpers or hardware switch settings are required.
- Ensure that the communication parameters within the network, including the Building Management System, are configured identically. See section 4.4.5: Modbus Configuration (MB-xx) on page 35.
- If the MGS-550 is at the end of the Modbus network, the terminating resistor must be set to "IN". All other instrument terminating resistor must be set to "OUT" (factory default). See section 4.4.5: Modbus Configuration (MB-xx) on page 35.

3.4.7 Conclusion

After all wiring is completed, be sure to replace components and seal the enclosure.

- Place the bezel and electronics circuit board back into the enclosure. Secure them to the standoffs with the three screws.
- For the general purpose (GP) instrument, put lid back on and tighten the four screws. For the explosion proof (XP) instrument, screw on the lid until it is seated, and then tighten the set screw.

SECTION 4. OPERATION

4.1 Overview of Normal Operation



WARNING

Before leaving the instrument for normal operation, check the configuration for proper settings and check calibration.

4.1.1 Applying Power and the Start-up Sequence

After applying power, the instrument will go through a start-up sequence (LED test, software version, and initialization) and start the warm-up period. The power LED will blink and, by default, the display will remain blank. To enable the display of gas type and concentration, use parameter P1-01 which will cause the display to toggle between the target gas name and a value of "0" for the sensor in warm-up. See section 4.4.6: Display Mode (P1-01) on page 35.

0.0.0.0.0.

0.0.0.0.0.

The instrument output will be OFFLINE (see section 4.3.1: Offline Mode (F-01) on page 25). If two sensors are installed, both target gas names and "0"s will be toggled sequentially.

0.0.0.0.0.
0.H4.0.0.

0.0.0.0.0.
0.0.0.0.0.



NOTICE

Note that sensor warm-up times may be different for dual sensor configurations. The power LED will continue to blink as long as at least one sensor is in warm-up.

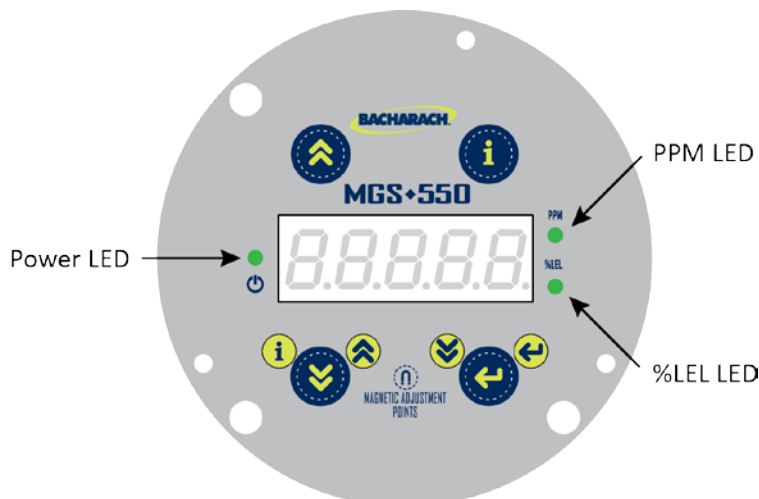

After the warm-up period, the instrument begins normal operation. The display toggles between the current gas concentration and target gas name.



During normal operation, the left green LED is lit solid. Depending on the unit of measurement, the green LED for ppm or %LEL is lit. If both of these LED are off, the unit of measurement is Vol%.

All configurations must be checked at least initially, and the calibration must be checked initially and as needed.

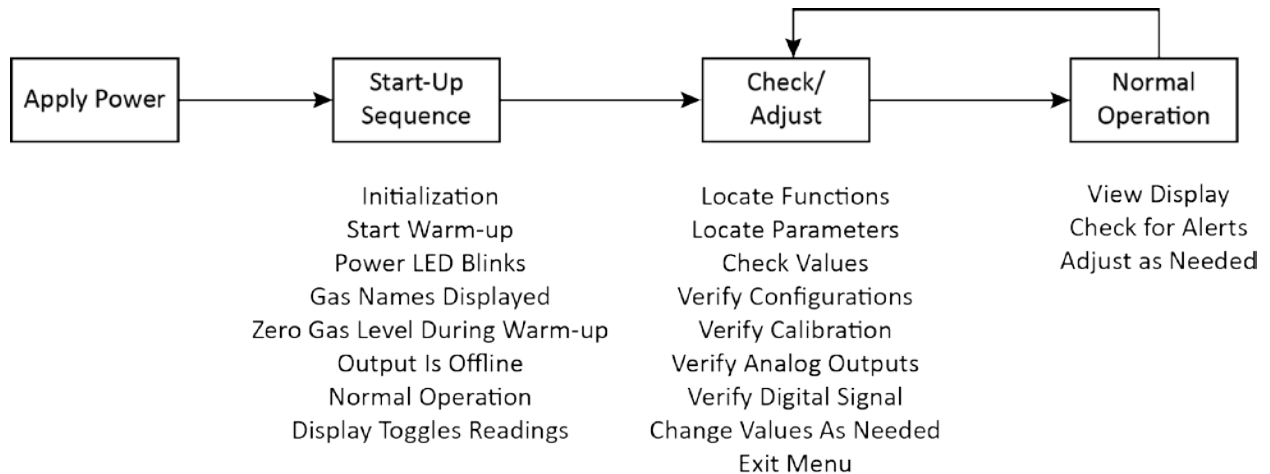

4.1.2 Verifying Analog Signals

During normal operation the current output of the instrument is proportional to the detected gas concentration and can be selected from the following.

- 4 to 20 mA
- 0 to 5 V
- 1 to 5 V
- 0 to 10V
- 2 to 10 V

The MGS-550 uses different current values to indicate various modes of operation. See section 9.1: General Specifications on page 62 for additional information.

4.1.3 Verifying the Digital Modbus Signal

The MGS-550 provides a Modbus RTU digital interface. All status messages and most parameters which can be accessed and/or configured through the menu can also be accessed and/or configured via a Building Management using a Modbus network. See section 4.4.5: Modbus Configuration (MB-xx) on page 35.

4.1.4 The 5-Digit Display and LEDs

In normal operation, the 5-digit, 7-segment LED display toggles between the gas name (CO₂ in this example, and the measured gas concentration (291 ppm in this example).



In addition, the following special symbols and unique messages may also be displayed during operation of the instrument.

Symbol/Message	Description
	The measuring range of the sensor has been exceeded ("upper hockey sticks" symbol).
	The sensor drifted negative (<0) ("lower hockey sticks" symbol).
	If a fault has been detected, the display toggles between gas name and "Exxx", and the green power LED is off. "E100" indicates a critical fault and "E300" indicates a non-critical fault. A non-critical fault does not need immediate attention, but should be mitigated at the next scheduled maintenance (see section 5: Maintenance on page 36). If a relay has been designated to the critical fault, it is asserted. E400 is a configuration warning that happens after a second sensor is added to warn the user that the sensor is not driving any relays or analog outputs.
	When the first alarm has been triggered, the display will toggle between gas name, "A1" and current gas concentration. If a relay has been designated to the first alarm, it is asserted.
	When the second alarm has been triggered the display will toggle between gas name, "A2" and current gas concentration. If a relay has been designated to the second alarm, it is asserted.
	When the third alarm has been triggered the display will toggle between gas name, "A3" and current gas concentration. If a relay has been designated to the third alarm, it is asserted.
	The instrument is offline. See section 4.3.1: Offline Mode (F-01) on page 25.
	The first character represents an "M". This is found in the Modbus parameters (MB-xx). Refer to section 4.4.5: Modbus Configuration (MB-xx) on page 35.
	This is a confirmation that is displayed before a sensor is registered. Tap [ENTER] to confirm registration of sensor 1 or registration of sensor 2. For more information, refer to section 4.3.6: Register Sensor (F-06) on page 26.
	This message is shown after successful completion of a functional operation of one of the sensors (for example, after registering a sensor, after calibrating a sensor, etc.).
	This is a confirmation display prior to de-registering all sensors and resetting node addresses (F-08). Tap [ENTER] to confirm reset. See section 4.3.8: De-register All Sensors and Reset Node Address (F-08) on page 27 for additional information.
	This is a second confirmation display prior to de-registering all sensors and resetting node addresses (F-08). Tap [ENTER] to confirm reset. See section 4.3.8: De-register All Sensors and Reset Node Address (F-08) on page 27 for additional information.

The unit of measurement is indicated by two green LEDs on the right side (upper LED for ppm, lower LED for %LEL, both LEDs off for Vol%). The green LED on the left indicates that the instrument is in normal operation.



NOTICE

If two sensors are installed for the same gas, but have different measuring ranges, the unique sensor identifier or UID (see label on the sensor) will be displayed in addition to the gas name.



NOTICE

Depending on the sensor and measuring range, the gas concentration may or may not be shown with a decimal point.

4.2 Menus









4.2.1 General Navigation

The MGS-550 offers two methods of navigating through the menu.

- Use the non-intrusive magnetic wand (tapping above the “magnetic” icons with dashes)
- Use the internal push buttons (pressing the push button points).



MGS-550 Fixed Gas Detector

Magnetic Switch Points		Internal Push Button Points	Function(s)
GP	XP		
			<p>Tapping/pressing and holding the [i] key for more than 3 seconds gives access to the user menu (which displays the firmware version first). It is also used to return to the next higher menu item without saving any changes (“escape”).</p> <p>A short tap/press (< 3 seconds) of the [i] key also brings up a sensor identification on the display, toggling between the serial number (UID) of Sensor 1 and Sensor 2.</p>
			<p>Tapping/pressing the magnetic wand over the [UP] / [DOWN] keys scrolls through the menu selections. Holding the magnetic wand at the key is interpreted as repeat tapping with an eventual acceleration.</p> <p>When the last menu item is reached, the menu will roll over to the first menu item in the list.</p> <p>A diagnostic scan can be entered from normal operation by tapping and holding [UP] for more than 3 seconds.</p>
			<p>Tapping/pressing the [ENTER] key (↵) confirms a selection.</p> <p>In normal operation tapping/pressing and holding the [ENTER] key for more than 3 seconds will cancel the OFFLINE mode, or release any latched alarm, or acknowledge any acknowledgeable alarm, with priority given to OFFLINE mode.</p>



NOTICE

The instrument is designed for the magnetic wand to be used with the enclosure lid in place. If the enclosure lid is not in place, the magnetic wand may activate two or more keys at once due to cross-talk.



NOTICE

After 3 minutes of inactivity within a *menu*, the instrument times-out and returns to normal operation.

When changing a parameter, 3 minutes of inactivity will cause the instrument to time out and return to normal operation *without* accepting any changes.

4.2.2 Checking Status and Changing Parameter Values

Select the menu item to be accessed by tapping [UP] / [DOWN].

- When the desired menu item is displayed, tap [ENTER]. The current value or status will flash to indicate the user interface has switched to data entry mode.
- [UP] / [DOWN] adjust the value of a numerical parameter or scroll through preset choices.
- Once the display shows the intended value or choice, tap [ENTER] to validate the new parameter and return to the previous menu.

4.2.3 Exiting the Menu

To get back into measurement mode, tap and hold the [i] key for more than 3 seconds. This will step back through the menus and eventually return to normal operation.

4.2.4 Menu Overview

The menu is divided in functions and parameters. Individual parameters are grouped into logical menus.

Function	Description																		
F-01	00 = instrument online, 01 = instrument OFFLINE																		
F-02	1 = zero sensor 1, 2 = zero sensor 2																		
F-03	1 = span sensor 1, 2 = span sensor 2																		
F-04	Instrument test																		
F-05	Access parameters: <table border="1" data-bbox="431 548 1078 949" style="margin-left: 40px;"> <thead> <tr> <th>Parameters</th> <th>Description</th> </tr> </thead> <tbody> <tr> <td>S1-XX</td> <td>Sensor 1 settings</td> </tr> <tr> <td>S2-XX</td> <td>Sensor 2 settings – if connected</td> </tr> <tr> <td>RX-XX</td> <td>Relay settings</td> </tr> <tr> <td>AF-XX</td> <td>Alarm functions</td> </tr> <tr> <td>AX-XX</td> <td>Analog output configuration</td> </tr> <tr> <td>MB-XX</td> <td>Modbus configuration</td> </tr> <tr> <td>P1-01</td> <td>Display mode</td> </tr> <tr> <td>B1-XX</td> <td>Buzzer settings</td> </tr> </tbody> </table>	Parameters	Description	S1-XX	Sensor 1 settings	S2-XX	Sensor 2 settings – if connected	RX-XX	Relay settings	AF-XX	Alarm functions	AX-XX	Analog output configuration	MB-XX	Modbus configuration	P1-01	Display mode	B1-XX	Buzzer settings
Parameters	Description																		
S1-XX	Sensor 1 settings																		
S2-XX	Sensor 2 settings – if connected																		
RX-XX	Relay settings																		
AF-XX	Alarm functions																		
AX-XX	Analog output configuration																		
MB-XX	Modbus configuration																		
P1-01	Display mode																		
B1-XX	Buzzer settings																		
F-06	Register sensor																		
F-07	De-register one sensor																		
F-08	De-register all sensors and reset node address																		
F-09	Access diagnostics, system information, and fault parameters																		
F-10	Reset system to factory default setting																		

An example of the layered structure of functions, menus, and parameters is illustrated below. Individual functions and parameters are described in detail in the sections that follow.

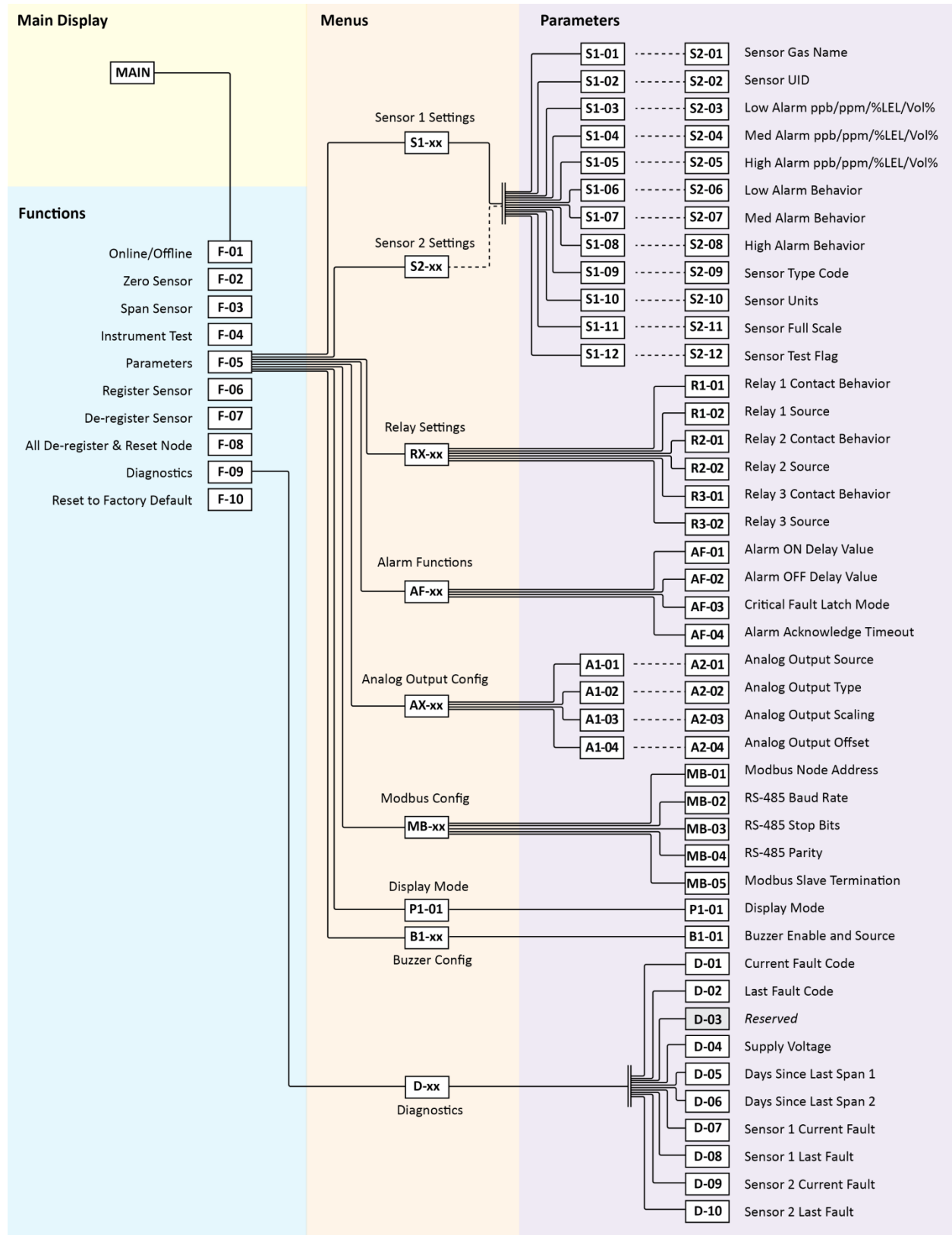

4.3 Functions

4.3.1 Offline Mode (F-01)

In OFFLINE mode the instrument does not respond to alarm conditions, but allows the execution of functions and the setting of parameters. OFFLINE mode is useful in eliminating false alarms while performing maintenance.

- To enter OFFLINE mode, change F-01 to 01.
- To cancel OFFLINE mode, change F-01 to 00 or tap and hold [ENTER] for more than 3 seconds from the top level menu.



NOTICE

OFFLINE mode automatically times out 30 minutes after returning to normal operation (i.e., after exiting the function menu).

Item	Behavior in OFFLINE Mode
Green LED	On
Display	Displays "oFFLn" or function and parameter numbers or user interaction in place of the gas level when applicable
Analog Output	4 to 20 mA Changes to 3 mA
	0 to 5 V Stays at last valid value
	0 to 10 V Stays at last valid value
	1 to 5 V 0 V
	2 to 10 V 0 V
Modbus Registers	Offline flag (Modbus register 10024) is active (must be monitored). Concentration registers stay at their last valid values.
Alarm States	Any pre-existing alarm condition is cancelled
Faults	Faults remain active, but actions based on any pre-existing fault are de-asserted (e.g., relays, buzzer, and Modbus flags).

4.3.2 Zero Adjustment (F-02)

This function is used to adjust the zero reference point of the sensor. See section 5.2.3: Zero Adjustment on page 38 for information.

4.3.3 Span Adjustment (F-03)

This function is used to adjust the sensitivity to match the known concentration of an applied calibration gas. See section 5.2.4: Span Adjustment on page 38 for information.

4.3.4 Instrument Test (F-04)

This function tests the relays, display, and analog outputs by temporarily overriding them. It might be necessary to inhibit the alarms at the central controller to avoid false alarms.

- Use the [UP] / [DOWN] key to select the test to be performed:
 - 1 = relay test
 - 2 = analog output test
 - 3 = display test.

After exiting this function, the instrument returns to the function menu and all test overrides are removed.

MGS-550 Fixed Gas Detector

#	Test	Description
1	Relay	The relay test changes the state of each relay. Use the [UP] / [DOWN] key to toggle the relay. Tap [ENTER] to test the next relay. Tap [i] to exit the function. Note that changing the state of the relays can trigger alarms in connected equipment.
2	Analog Output	<p>The analog output test allows you to set the output for interface test purposes (e.g., to check the programming of a central controller). Tapping [ENTER] will set the analog output to the level equivalent to <i>zero gas</i>. For a 4 to 20 mA configuration this output will be 4 mA; for a 1 to 5 V configuration this output will be 1 V; and so on. Use the [UP] / [DOWN] key to change the value of the zero output.</p> <p>After tapping [ENTER], the analog output will be set to <i>full scale</i>. Use the [UP] / [DOWN] key to adjust the value of the <i>full-scale</i> output.</p> <hr/> <div style="display: flex; align-items: center;">  <div style="margin-left: 10px;"> <p>Changing the analog outputs can trigger alarms in connected equipment.</p> </div> </div> <hr/>
3	Display	The display test lights up all segments and LEDs.

4.3.5 Parameter Menu (F-05)

Use this function to access the parameter menu. See section 4.2.4: Menu Overview on page 23 and section 4.4: Parameters on page 29 for detailed information.

4.3.6 Register Sensor (F-06)

Function F-06 is used to register a new sensor without having to cycle power.

In general, sensor registration is the association of parameters in the instrument to the set in the sensor. Registration occurs at the factory for the local sensor and is based on the sensor configuration that is ordered. If the sensor configuration must be changed (e.g., changing a sensor type or adding a second sensor), then the new sensor *must* be registered.



CAUTION

Before unplugging ANY sensor, it must be de-registered using function F-07.

Failure to do this will require you to de-register all sensors using F-08 (with the sensors still connected to the main electronics), remove the sensors, and then re-install and re-register the sensors one at a time using function F-06.

If the sensors are not connected when an F-08 is performed, then their node addresses will not be reset. Refer to CAUTION on the following page.

Generally, a *new* sensor is discovered and registered automatically when the following occurs:

- power is shut off
- the new sensor is connected, and
- power is then restored.

For example, if you wish to add a second sensor to a previously installed single-sensor system, simply turn off power, add the new sensor to the available (previously unoccupied) sensor connector, and turn on power. Upon power up, the instrument will recognize and register the new sensor that you installed in the previously unfilled slot.

If it is inconvenient or impractical to cycle power to automatically register a new sensor, then the process is performed manually using the Register Sensor function F-06.



New sensors all have address 100. The first sensor registered will be sensor #1 and the second sensor #2.

Resetting sensor registration through F-08 will reset them all to 100; then they need to be registered one at a time.

To register a newly added sensor, select F-06 and tap [ENTER]. There are 3 possible scenarios.

Scenario	Description
Sensor is already registered	If there is already one sensor connected and it has already been registered, the F-06 display is shown after a brief delay.
Normal registration/ adding a sensor	If the newly added sensor was previously unregistered or de-registered (i.e., address 100), "reg 1" or "reg 2" will be displayed (depending on the configuration). Tap [ENTER] to confirm registration of the sensor. "PASS1" or "PASS2" will be displayed.
Address conflict	If a sensor was previously registered in an instrument, was not de-registered, was removed, and then plugged in to a different instrument, then a critical fault (E100 error) will occur. Refer to function F-08 to resolve.

4.3.7 De-register One Sensor (F-07)

This function resets the registration of a sensor and changes a 2-sensor system to a 1-sensor system.



NOTICE

Removing a sensor without first de-registering it will result in a fault. Always de-register a sensor before permanently removing it.

Tap [ENTER] to display the unique sensor identifier (UID). Use the [UP] / [DOWN] keys to select the sensor to be removed. After tapping [ENTER], the sensor can be disconnected. See section 5.4: Sensor Maintenance on page 44 for information.



NOTICE

A sensor's user-editable parameters (e.g., alarm setpoints, etc.) are not retained after it is de-registered. If a sensor is registered again, all parameters will be set to their factory default values.

4.3.8 De-register All Sensors and Reset Node Address (F-08)

Two sensors connected to the instrument that have the same node address will result in a fault. Function F-08 can be used to recover from this situation by resetting the registration of all sensors and resetting their node addresses to 100.

- Tap [ENTER]. The instrument will show "Reset".
- Tap [ENTER] to confirm reset. Instrument will show a second confirmation ("sure").
- Tap [ENTER] again to reset the node address. "Pass" will be displayed.
- Unplug the sensors.
- Plug in one sensor and register it. See section 4.3.6: Register Sensor (F-06) on page 26.
- Plug in second sensor and register it.

Be sure to plug in the sensors and re-register them one at a time to avoid address conflicts.



CAUTION

Before unplugging ANY sensor, it must be de-registered using function F-07. Failure to do this will require you to de-register all sensors using F-08 (with the sensors still connected to the main electronics), remove the sensors, and then re-install and re-register the sensors one at a time using function F-06. If the sensors are not connected when an F-08 is performed, then their node addresses will not be reset.

4.3.9 Diagnostics, System Information and Fault Data (F-09)

This function will display any diagnostics and fault codes.

- Tap [ENTER] to initiate the function.
- Use the [UP] / [DOWN] keys to select a diagnostics code.
- After tapping [ENTER], the respective code will be displayed.

See section 5.3: Troubleshooting on page 39 for additional information.



NOTICE

The diagnostics attributes can be accessed directly during normal operation by tapping and holding [UP] for more than 3 seconds.

4.3.10 Reset System to Factory Default Setting (F-10)

This function will restore factory default values of all application specific parameter settings. See section 6: Factory Default Settings on page 57 for a list.



NOTICE

Resetting the system to its factory default values will *not* reset sensor calibrations.



NOTICE

Function F-10 resets *all* parameters (except sensor registration information) to their factory default values (see Factory Default Settings on page 57). Before executing this function, consider recording all parameter settings in case you wish to reset one or more of them to their former values.

- Tap [ENTER] to initiate this function. A "SURE" confirmation prompt is given.
- Tap [ENTER] to confirm the reset.
- All LED segments will light up for 3 seconds.
- Parameter settings will change to factory default values.
- The internal buzzer will sound for 3 seconds.
- After another 3 seconds the instrument will return to the main menu.

After an F-10 system reset, the instrument will be in a "known state", and the parameters can be set.

4.4 Parameters

4.4.1 Sensor 1 Settings (S1-xx) and Sensor 2 Settings (S2-xx) if Connected

S1 & S2 Param		Name (<i>n</i> =1 or 2)	Description (<i>n</i> =1 or 2)
S1-01	S2-01	Sensor <i>n</i> Gas Name	Abbreviated Gas Name
S1-02	S2-02	Sensor <i>n</i> UID	Unique 5-digit sensor ID (serial number)
S1-03	S2-03	Sensor <i>n</i> Low Alarm ppb/ppm/%LEL/Vol%	Value above which a low alarm condition occurs. Low alarm value must be less than the medium and high alarm values ($S_{n-03} < S_{n-04} < S_{n-05}$). (See oxygen sensor notice below.) This parameter has a fixed minimum limit that is sensor-specific and not editable.
S1-04	S2-04	Sensor <i>n</i> Medium Alarm ppb/ppm/%LEL/Vol%	Value above which a medium alarm condition occurs. Medium alarm value must be between low and high alarm values ($S_{n-03} < S_{n-04} < S_{n-05}$). (See oxygen sensor notice below.)
S1-05	S2-05	Sensor <i>n</i> High Alarm ppb/ppm/%LEL/Vol%	Value above which a high alarm condition occurs. High alarm value must be greater than low and medium alarm values ($S_{n-03} < S_{n-04} < S_{n-05}$). (See oxygen sensor notice below.)
S1-06	S2-06	Sensor <i>n</i> Low Alarm Behavior	0 = Disabled 1 = Non-latching, not acknowledgeable
S1-07	S2-07	Sensor <i>n</i> Medium Alarm Behavior	2 = Non-latching, acknowledgeable
S1-08	S2-08	Sensor <i>n</i> High Alarm Behavior	3 = Latching, not acknowledgeable 4 = Latching, acknowledgeable
S1-09	S2-09	Sensor <i>n</i> Type Code	4-digit sensor code (read-only)
S1-10	S2-10	Sensor <i>n</i> Units	Read-Only. Sensor <i>n</i> measurement units: 1 = ppm 2 = ppb 3 = Vol% 4 = %LEL
S1-11	S2-11	Sensor <i>n</i> Full Scale	Read-Only. Sensor <i>n</i> full-scale units: ppb or ppm or Vol% or %LEL.
S1-12	S2-12	Sensor <i>n</i> Test Flag	When set to 1, this flag indicates that a calibration is recommended. This flag can be reset to 00 by either successfully completing a span adjustment (see section 5.2.4: Span Adjustment on page 38) or by changing the value manually. 0 = Sensor OK 1 = Sensor in operation for >6 months without calibration. Recalibration recommended.

The following parameters are sensor dependent.

- Low alarm limit (S1-03 and S2-03)
- High alarm limit (S1-05 and S2-05)
- Unit of measurement (S1-10 and S2-10)
- Factory default values for the alarm thresholds



A fixed hysteresis of 5% of full scale is set in order to avoid chatter at an alarm threshold.

For all instruments except oxygen, the alarm occurs on gas concentrations that increase beyond the set-points.

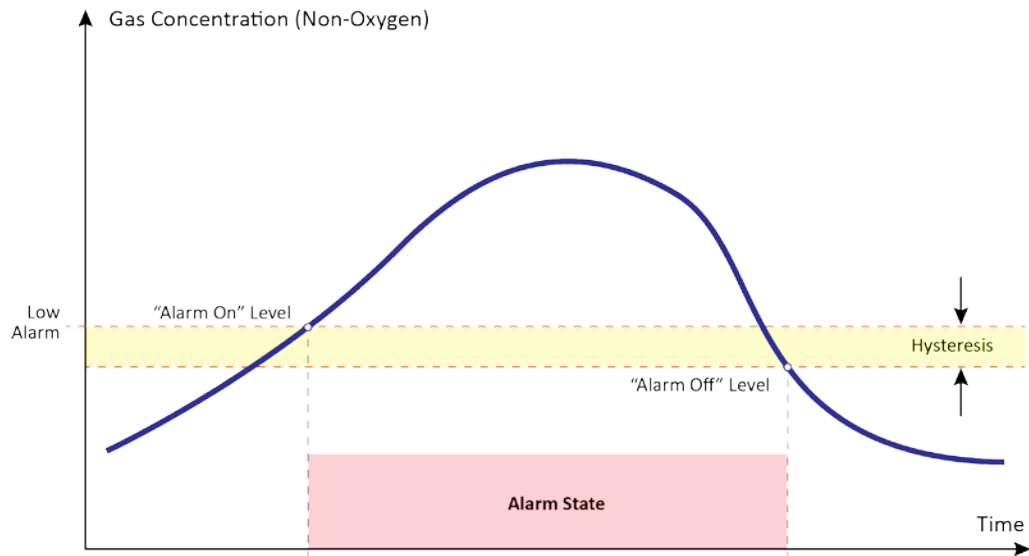

For all instruments monitoring oxygen, the low and medium alarms occur on concentrations that decrease below the set-points. The high alarm occurs on gas concentrations that increase beyond the set-point. This permits the detection of oxygen displacement and enrichment scenarios.

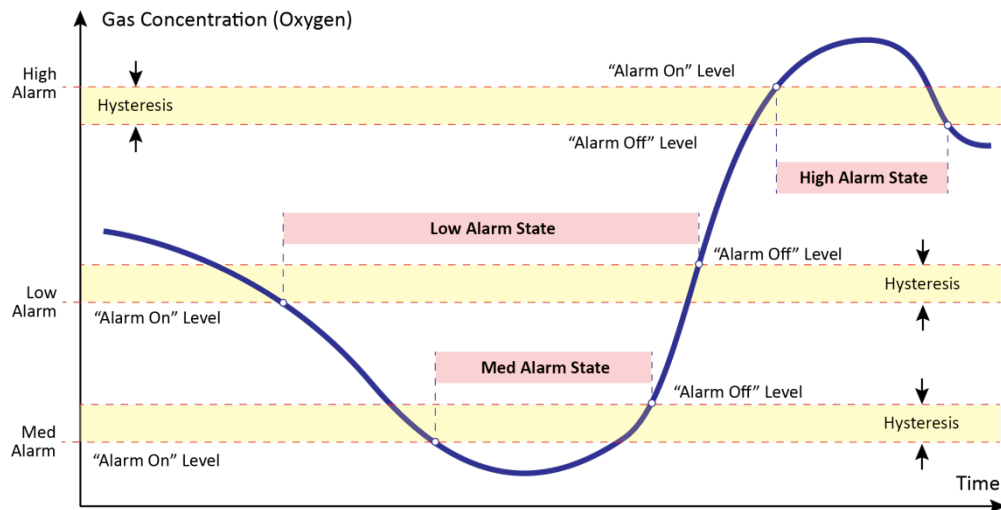

Alarm hierarchy exists. An A2 alarm overrides an A1 alarm on the display. However, the A1 and A2 states operate independently. An example follows.

- A1 is acknowledgeable
- A2 is not acknowledgeable
- The gas concentration is such that it triggers A1 and A2

Acknowledging will cause the A1 relay to release. However, the display will still show an A2 alarm as long as the A2 condition continues to exist. The same is true for A3 and A2.



NOTICE

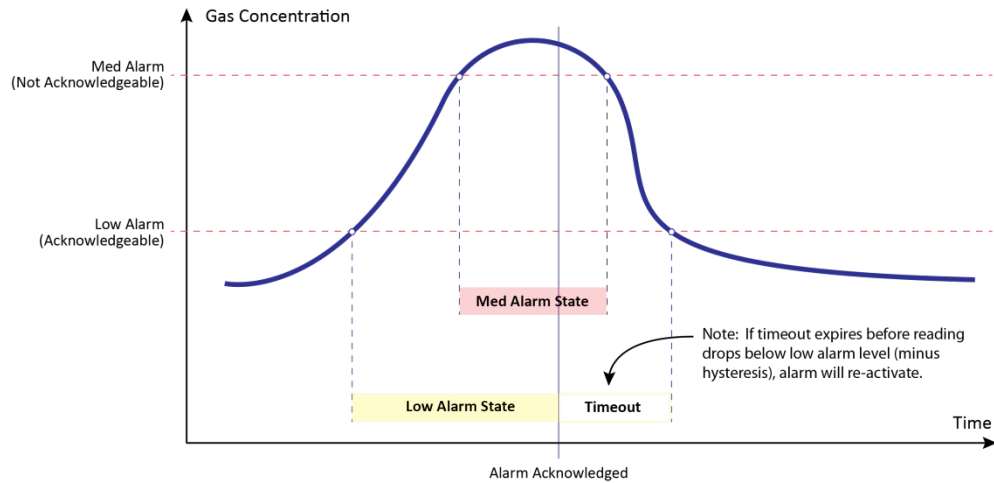

Latching and acknowledgment settings of alarms may be combined to create unique scenarios.

- Latching means that once the alarm level is reached, the instrument will trigger the alarm and it will remain in alarm status even if the gas concentration subsequently does not meet the alarm condition any more. To clear a latching alarm it has to be acknowledged by tapping and holding [ENTER] for more than 3 seconds.
- Non-latching means that the alarm status clears if the gas concentration does not meet the alarm condition anymore.
- Acknowledgeable means that the alarm relay can be reset before the alarm condition clears.
- Not acknowledgeable means that the alarm relay cannot be reset until the alarm condition clears.



NOTICE

Latching	Acknowledgeable	Explanation
No	No	The alarm state will reset automatically when the alarm condition clears. The alarm state cannot be reset manually before the alarm condition clears.
No	Yes	The alarm state will reset automatically when the alarm condition clears or can be reset manually.
Yes	No	The alarm state must be reset manually. The alarm state cannot be reset before the alarm condition clears.
Yes	Yes	The alarm state must be reset manually and can be reset before the alarm condition clears.

Latching and acknowledgment does not just affect relay states, but also the buzzer state and Modbus status flags.

MGS-550 Fixed Gas Detector

4.4.2 Relay Designation (RX-xx)

Parameter	Name	Description
R1-01	Relay 1 Contact Behavior	Select behavior for Relay 1: 0 = NO, 1 = Failsafe.
R1-02	Relay 1 Source	Select alarm configuration (01 to 14) to activate Relay 1: 01: Sensor 1 Low Alarm 02: Sensor 1 Medium Alarm 03: Sensor 1 High Alarm 04: Sensor 1 Fault 05: Sensor 2 Low Alarm 06: Sensor 2 Medium Alarm 07: Sensor 2 High Alarm 08: Sensor 2 Fault 09: Instrument Electronics Critical Fault 10: Any Low Alarm 11: Any Medium Alarm 12: Any High Alarm 13: Any Sensor Fault or Instrument Electronics Critical Fault 14: Any Alarm or Sensor Fault or Instrument Electronics Critical Fault
R2-01	Relay 2 Contact Behavior	Select behavior for Relay 2: 0 = NO, 1 = Failsafe.
R2-02	Relay 2 Source	Select alarm configuration (01 to 14) to activate Relay 2. See R1-02 above for source codes.
R3-01	Relay 3 Contact Behavior	Select behavior for Relay 3: 0 = NO, 1 = Failsafe.
R3-02	Relay 3 Source	Select alarm configuration (01 to 14) to activate Relay 3. See R1-02 above for source codes.

The relays can be independently designated to any configuration below.

For example, consider a 2-sensor system with relays configured as follows:

- R1-02=01 Relay 1 configured as 01 (Sensor 1 Low Alarm)
- R2-02=06 Relay 2 configured as 06 (Sensor 2 Medium Alarm)
- R3-02=13 Relay 3 configured as 13 (Any Sensor Fault or Instrument Electronics Critical Fault).

In this configuration, the following would occur:

- Relay 1 will activate when the low alarm of sensor 1 is triggered
- Relay 2 will activate when the medium alarm of sensor 2 is triggered
- Relay 3 will activate when any sensor or instrument fault occurs (either sensor).



It is possible to dedicate the same alarm configuration to multiple relays. For example, sensor 1 high alarm could be mapped to relay 1 and relay 2 (for redundancy).



CAUTION

With integrated relays, the instrument can be operated stand-alone without a central controller (with additional local alarm signaling). It is recommended to designate one relay as fault relay (e.g., configuration 13).

4.4.3 Alarm Configuration (AF-xx)

Parameter	Name	Description
AF-01	Alarm ON Delay Value	<p>00 = no delay, 01 to 15 = delay in minutes.</p> <p>If an alarm ON delay is set, the gas concentration has to be continuously above (below for oxygen low and medium alarms) the alarm threshold for the delay time before the alarm is triggered or activated.</p> <hr/>  <p>Once programmed, all alarms have the same ON delay.</p> <p>NOTICE</p> <hr/>
AF-02	Alarm OFF Delay Value	<p>00 = no delay, 01 to 15 = delay in minutes.</p> <p>If an alarm OFF delay is set, the gas concentration has to be continuously below (above for oxygen low and medium alarms) the alarm threshold for the delay time before the alarm is deactivated. If the alarm is acknowledgeable, the alarm OFF delay will be terminated as soon as it is acknowledged.</p> <hr/>  <p>Once programmed, all alarms have the same OFF delay.</p> <p>NOTICE</p> <hr/>
AF-03	Critical Fault Latch Mode	<p>0 = non-latching, 1= latching</p> <p>Latching means that any critical fault state will remain active (even if the event creating the fault is cleared) until the user <i>manually clears</i> the fault state with the "ENTER" key.</p>
AF-04	Alarm Acknowledge Timeout	<p>00 = no timeout, 01 to 59 = delay in minutes</p> <hr/>  <p>If an alarm state has been acknowledged, but the condition still exists <i>after</i> the timeout period, the alarm state will be triggered again.</p> <hr/>

4.4.4 Analog Output Configuration (AX-xx)

Parameter	Name	Description
A1-01	Analog Output 1 Source	1 = Sensor 1 2 = Sensor 2
A1-02	Analog Output 1 Type	0 = 0 to 5 V 1 = 1 to 5 V 2 = 0 to 10 V 3 = 2 to 10 V 4 = 4 to 20 mA
A1-03	Analog Output 1 Scaling	<p>Scales the FSD (full-scale deflection), i.e., the measuring range, between 20 and 100% FSD, to the maximum analog output (e.g., 20 mA). The selected full scale deflection determines the analog output (e.g., 20 mA signal) on the analog interface.</p> <p>Example: Consider an application with a required range of 0 to 20,000 ppm CO₂ with a min and max of 4,000 ppm and 20,000 ppm, respectively.</p> <p>To select full scale deflection as 10,000 ppm, set this parameter to 50%. The analog output will be linear between 4 mA (= 0 ppm) and 20 mA (= 10,000 ppm). However, the resolution of the sensor stays at the value for the max range.</p> <hr/> <div style="display: flex; align-items: center;">  <p>Alarm thresholds will not be changed when scaling the analog output. These must be set separately. See section 4.4.1: Sensor 1 Settings (S1-xx) and Sensor 2 Settings (S2-xx) if Connected on page 29.</p> </div> <hr/> <p>NOTICE</p>
A1-04	Analog Output 1 Offset	<p>Sets an analog offset ($\pm 410 = \pm 10\%$ of full scale) at the zero point. This parameter adds an offset to the analog output. The offset is constant over the entire range of the analog signal. No re-calibration necessary. This parameter is essential for an installation where the analog current at the instrument differs from the current at the central controller.</p> <p>Note: The offset can be positive or negative, but can't take the output below the zero gas level (e.g., 4 mA for 4-20 mA).</p>
A2-01	Analog Output 2 Source	Same as A1-01, but for output 2 (see description above).
A2-02	Analog Output 2 Type	Same as A1-02, but for output 2 (see description above).
A2-03	Analog Output 2 Scaling	Same as A1-03, but for output 2 (see description above).
A2-04	Analog Output 2 Offset	Same as A1-04, but for output 2 (see description above).

4.4.5 Modbus Configuration (MB-xx)

Parameter	Name	Description
MB-01	Modbus Node Address	Set the RS-485 node address (001 to 255)
MB-02	RS-485 Baud Rate	0 = 9600 1 = 19200
MB-03	RS-485 Stop Bits	1 or 2
MB-04	RS-485 Parity	0 = None 1 = Odd 2 = Even
MB-05	Modbus Slave Termination	0 = Out 1 = In

4.4.6 Display Mode (P1-01)

Parameter	Name	Description
P1-01	Display Mode	Defines whether or not the gas name and concentration are displayed during normal operation. 0 = OFF (gas name and concentration will not be shown) 1 = ON (gas name and concentration will be shown) If an alarm or fault condition occurs, the display will be turned on to show the error code(s).

4.4.7 Buzzer Designation (B1-xx)

Parameter	Name	Description
B1-01	Buzzer Enable and Source	Select alarm configuration (01 to 14) to activate Buzzer. 00 = Buzzer disabled

Each MGS-550 has a built-in buzzer which can be designated to any alarm configuration. Refer to section 4.4.2: Relay Designation (RX-xx) on page 32 for a list of alarm configurations.

SECTION 5. MAINTENANCE

5.1 Maintenance Intervals

Interval	Function
During Commissioning	Check calibration.
	Check signal transmission to the central controller.
	Check LEDs for proper operation.
	Check for proper triggering of alarm devices.
Every 6 Months*	Inspection by trained service personnel.
	Check signal transmission to the central controller.
	Check LEDs for proper operation.
	Check for proper triggering of alarm devices.
	Calibrate the sensor or contact Bacharach for sensor exchange with factory-calibrated sensor.
As Required	Replace sensor(s). See section 5.4 Sensor Maintenance on page 44.

* Maintenance intervals must be established for each individual installation. Depending on safety considerations, application-specific conditions, and local regulations, the 6-month maintenance intervals might need to be shortened.

5.2 Making Adjustments to Sensors

5.2.1 Introduction

Adjustment of the instrument must be performed at regular intervals as detailed above.



WARNING

Breathing Hazard: Calibration gas must not be inhaled! See appropriate Material Safety Data Sheets. Calibration gas should be vented into a fume hood or to the outside of the building.



WARNING

Zero First, Then Span: For proper operation, never adjust the span *before* completing a zero adjustment. Performing these operations out of order will cause faulty calibration.



WARNING

Bacharach recommends calibrating instruments within the application-specific condition and with target gas. This method of zeroing the instrument in the application environment and performing a target gas calibration is more accurate. A surrogate gas calibration may only be performed as an alternative if a target gas calibration is not possible.



NOTICE

The sensor should be fully warmed-up (refer to section 4.1.1: Applying Power and the Start-up Sequence on page 18).

**NOTICE**

When entering the functions F-02 (zero adjustment) or F-03 (span adjustment), the instrument will automatically enter OFFLINE mode. The instrument will remain OFFLINE until either the OFFLINE mode is canceled using function F-01 (see section 4.3.1: Offline Mode (F-01) on page 25), or the OFFLINE mode times out within 30 minutes after the adjustment has ended. This is to avoid false alarms caused by residual cal gas.

If the adjustment has not been completed, the instrument will abort the zero or span adjustment after 5 minutes of the last of interaction. No new data will be saved and the instrument remains OFFLINE.

5.2.2 General Procedure

- Ensure the instrument has been powered on for at least 1 hour prior to beginning the sensor adjustment procedure. For semiconductor sensors, you must wait at least 24 hours.
- Attach the pressure regulator to the calibration gas cylinder.
- Attach tubing to the pressure regulator.
- Attach calibration adapter to the tubing.
- For the general purpose type sensors (see figure below), connect the tubing to the calibration port (the barbed fitting) of the splash guard.
- Push the calibration adapter over the sensing head assembly.
- The gas flow should be approximately 0.3 to 1.0 L/min.
- Access the appropriate function (as needed) and begin the zero, span, or bump test.

**NOTICE**

If the intended operation is at higher altitudes, the factory calibration will result in a reading that is lower than the reading at sea level (a result of reduced partial pressure). A new span adjustment is recommended if the altitude or the ambient pressure is changed. The factory calibration is set to sea level.

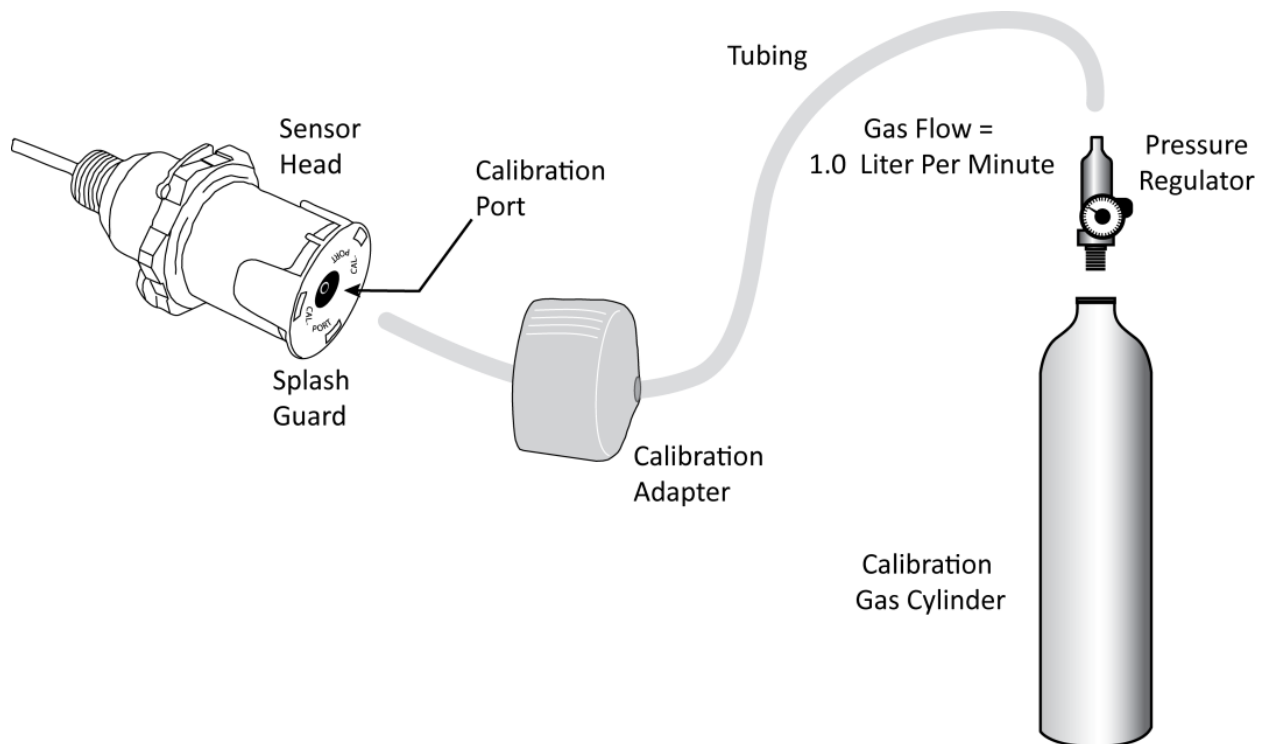

5.2.3 Zero Adjustment



WARNING

Ambient air can be used to zero the sensor instead of nitrogen or synthetic air *only* if the area is known to be free of the target gas or any gas to which the sensor may be cross-sensitive (as listed on the sensor data sheet). In this case, no cylinder or calibration adapter is needed for the zero adjustment. For semiconductor sensors, you must use synthetic air only.



WARNING

For oxygen (O₂) and carbon dioxide (CO₂) sensors, use *only* nitrogen (N₂) gas.

- Enter the menu and select function F-02 Zero Sensor.
- Use [UP] / [DOWN] to select the sensor to be calibrated, then tap [ENTER].
- Apply “synthetic” air (i.e., 20.9% zero air) or nitrogen (see section 5.2.2: General Procedure on page 37) and tap [ENTER]. The display will show the current value blinking (e.g., “2”). The gas value may go negative. This is normal.
- Wait for the current gas concentration value to stabilize.
- Tap [ENTER] to save the calibration data.
- The instrument will indicate success status with a “PASS” display. Otherwise a “FAIL” message is displayed.
- Turn off gas flow and remove the calibration adapter from the sensor or disconnect the tubing.
- For oxygen, ensure that the concentration is above the displacement alarm thresholds.
- Tap [ENTER] to exit the function.

5.2.4 Span Adjustment

- Enter the menu and select function F-03 Span Sensor.
- Use [UP] / [DOWN] to select the sensor to be calibrated, then tap [ENTER].
- The last span gas concentration will be displayed.
- Use [UP] / [DOWN] to change the value to match the concentration of the calibration gas (in the units of the sensor – i.e., ppm, Vol %, %LEL, etc.), and tap [ENTER].
- Apply span gas (see section 5.2.2: General Procedure on page 37) and tap [ENTER].
- The display will show the current gas concentration value blinking in the units of the sensor – i.e., ppm, Vol %, %LEL, etc. (e.g., “100”).
- Wait for the current gas concentration value to stabilize.
- Tap [ENTER] to perform the calibration adjustment.
- The instrument will indicate success status with a “PASS” display. Otherwise a “FAIL” message is displayed.
- Turn off gas flow and remove the calibration adapter from the sensor or disconnect the tubing.
- Ensure that the concentration is below the alarm thresholds.
- For oxygen, ensure that the concentration is below the enrichment alarm thresholds.
- Tap [ENTER] to exit the function.

5.2.5 System Bump Test

A system bump test is a live test of a **system** to verify that the instrument responds to gas and that all connected alarm devices, controllers, etc. are operating appropriately. In this case, be sure to inform all involved persons about the test and that certain alarms might have to be inhibited (e.g., process shutdown, notification of authorities, etc.)

- Apply target gas; if required a sufficiently high concentration (low concentration for oxygen displacement) to trigger alarms.
- The display will show the current gas concentration value.

- Once the alarm thresholds are exceeded, verify that all designated gas alarm relays are activated and the analog and digital outputs properly transmitted the corresponding gas concentrations.
- Turn off gas flow and remove the calibration adapter from the sensor or disconnect the tubing.

5.3 Troubleshooting

5.3.1 Hexadecimal Format

All fault codes are shown in hexadecimal (hex) format. A hex digit can represent multiple codes as shown below.

Hex Code	Equivalent Error Code(s)	Hex Code	Equivalent Error Code(s)	Hex Code	Equivalent Error Code(s)	Hex Code	Equivalent Error Code(s)
0	0	4	4	8	8	C	4 + 8
1	1	5	1 + 4	9	1 + 8	D	1 + 4 + 8
2	2	6	1 + 2 + 3	A	2 + 8	E	2 + 4 + 8
3	1 + 2	7	1 + 2 + 4	B	1 + 2 + 8	F	1 + 2 + 4 + 8

5.3.2 Diagnostics Attributes

Attribute	Description
D-01	<p>Reads the current instrument fault code xxxx:</p> <p>0000 = No faults</p> <p>0001 = Reported temperature outside operating range (Non-critical, E300)</p> <p>0002 = Master RX buffer full (Non-critical, E300)</p> <p>0004 = Slave RX buffer full (Non-critical, E300)</p> <p>0008 = CRC error in received packet (Non-critical, E300)</p> <p>0010 = CRC error in received packet (Non-critical, E300)</p> <p>0020 = Packet timeout (Non-critical, E300)</p> <p>0040 = Either Current loop open (Non-critical, E300)</p> <p>0080 = Stuck key or magnetic switch (Non-critical, E300)</p> <p>0100 = No registered sensors (Critical, E100)</p> <p>0200 = Sensor 1 reporting a critical fault (Critical, E100)</p> <p>0400 = Sensor 2 reporting a critical fault (Critical, E100)</p> <p>0800 = Sensor 1 is registered, but not responding correctly or wrong sensor installed (Critical, E100)</p> <p>1000 = Sensor 2 is registered, but not responding correctly or wrong sensor installed (Critical, E100)</p> <p>2000 = Power supply voltage(s) out of range (Critical, E100)</p> <p>4000 = MPU clock fault (Critical, E100)</p> <p>8000 = Can't read EEPROM (Critical, E100)</p> <p>For more information on these faults, refer to table in section 5.3.3: Instrument Electronics Critical (E100) Faults on page 41 and section 5.3.4: Non-Critical (E300) Faults on page 42. Refer to section 5.3.1 Hexadecimal Format on page 39 for combined codes.</p>
D-02	Displays the last fault that occurred since first start-up or since the data logger was last erased. See D-01 for more information. Tap [ENTER] to clear.
D-03	<i>Reserved</i>
D-04	Supply voltage
D-05	Number of days since the last span calibration of Sensor 1. This value automatically resets to 0000 after completing a span adjustment via F-03.

MGS-550 Fixed Gas Detector

Attribute	Description
D-06	Number of days since the last span calibration of Sensor 2. This value automatically resets to 0000 after completing a span adjustment via F-03.
D-07	<p>Sensor 1 current fault code xxxx:</p> <ul style="list-style-type: none"> 0000 = No faults 0001 = No sensor signal 0002 = Sensor board hardware fault 0004 = EEPROM checksum fault 0008 = Zero adjust out of range 0010 = Span adjustment out of range 0020 = Input voltage fault 0040 = Microprocessor fault 0080 = Software fault 0100 = RS485 receiver fault 0200 = RS485 checksum fault 0400 = Modbus fault 0800 = Temperature sensor fault 1000 = Temperature out of range fault 2000 = Analog front end communications fault 4000 = Negative gas concentration fault 8000 = Sensor configuration fault <p>For more information on these faults, Refer to table in section 5.3.5: Sensor Faults on page 42. Refer to section 5.3.1: Hexadecimal Format on page 39 for combined codes.</p>
D-08	Sensor 1 last fault code. See D-07 list. To clear tap [ENTER].
D-09	Sensor 2 current fault code. Same as D-07. See D-07 list.
D-10	Sensor 2 last fault code. See D-07 list. To clear tap [ENTER].

5.3.3 Instrument Electronics Critical (E100) Faults

Critical faults are indicated by “E 100” on the display. Critical faults indicate a functional problem that results in the gas detector no longer monitoring gas reliably. See D-01 and D-02.

Code	Critical Fault	Possible Causes	Remedy
0200	Sensor 1 critical fault	No sensor or defective sensor.	Add sensor. Replace sensor.
		Sensor removed and not deregistered.	Deregister sensor, then remove. See section 4.3.7: De-register One Sensor (F-07) on page 27.
		Two with same node address.	De-register both sensors and re-register them one at a time. See section 4.3.8: De-register All Sensors and Reset Node Address (F-08) on page 27 and section 4.3.6: Register Sensor (F-06) on page 26.
0400	Sensor 2 critical fault	Same as Sensor 1. See above.	Same as Sensor 1. See above.
0800	Sensor 1 error	Sensor is registered, but not responding correctly or the wrong sensor installed.	Sensor was removed. Replace sensor.
1000	Sensor 2 error		Sensor was replaced without re-registration. Register sensor. See section 4.3.6: Register Sensor (F-06) on page 26.
2000	One or more power supply voltages out of range	Input supply power to the MGS-550 is out of range.	Correct the input supply voltage to restore normal operation. See section 9.1: General Specifications on page 62.
4000	Micro-processor fault	Internal electronics hardware error.	Cycle power to the instrument. A possible hardware problem may exist. Contact the factory.
8000	Can't read EEPROM		

MGS-550 Fixed Gas Detector

5.3.4 Non-Critical (E300) Faults

Non-critical faults are indicated by “E 300” on the display. Non-critical faults indicate issues such as environmental conditions being outside of specification, an installation error has occurred (wrong wiring, for example), and so on.

The gas detector will continue to monitor, but *may* produce less accurate readings and may not respond correctly to gas alarm events. A non-critical fault might not need immediate attention, but should be mitigated at the next scheduled maintenance (at the latest). See D-01 and D-02.

Code	Non-Critical Fault	Possible Causes	Remedy
0001	Reported temperature outside operating range	Instrument temperature is outside specification	Verify that ambient air conditions are within specifications range for the instrument (see section 9.1: General Specifications on page 62) and for the sensor (see section 9.2: Sensor Specifications on page 63). Correct ambient air conditions.
0002	Master receiver buffer full	RS-485 Message too long for receiver buffer	Cycle power to the instrument. Cycle power to the PLC or control system (if applicable). Verify proper shielding on network communications wiring. Refer to section 3.1: General Information for Installation on page 11 and section 9.1: General Specifications on page 62 for more information. Verify proper grounding of the communications wiring. Refer to section 0: Connecting One or More MGS-550s to a Bacharach Controller on page 17. Verify proper communications settings for the network. Refer to section 4.4.5: Modbus Configuration (MB-xx) on page 35 for more information. A possible hardware problem may exist. Contact the factory.
0004	Slave receiver buffer full		
0008	Checksum (CRC) error in received packet	Transmission is corrupted (computed checksum doesn't match transmitted checksum)	
0010	Checksum (CRC) error in received packet		
0020	Packet timeout	Modbus message was truncated or timed out early	
0040	Either current loop open	Possible wiring, connection, and/or termination issue exists. Analog output is set to 4 to 20 mA and loop is open.	Wire pin 3 to 4 or pin 5 to 6 on analog output 4 to 20 mA terminal. (See section 3.4.1: Preparations on page 12.) Check the integrity of the 4 to 20 mA connections to the interface PCB

5.3.5 Sensor Faults



NOTICE

If a sensor fault occurs during a gas alarm condition, then the fault overrides the alarm condition for that sensor (i.e., the alarm state(s) for that sensor “de-assert” and the display shows “E 100”). Similarly, if a critical fault occurs, then all active alarm conditions will “de-assert”.

Sensor faults (for diagnostic attributes D-07 to D-10) may be decoded using the following table. Note that several faults may be reported at the same time (see section 5.3.1: Hexadecimal Format on page 39 for more information). For example, fault code “0003” is a combination of fault codes 0001 (No sensor signal) and 0002 (sensor board hardware fault). See D-07 through D-10.



If a “last fault” attribute (D-08 or D-10) indicates that a fault has occurred at some point in time, but the corresponding “current fault” attribute (D-07 or D-09) shows no fault, then the problem has self-healed and no service action is required.

NOTICE

Code	Sensor Fault	Possible Causes	Remedy
0000	No Fault		
0001	No sensor signal	Cannot detect sensor	Check all connections in the sensing head. Check connections to the interface board.
0002	Sensor board hardware fault	Cannot read EEPROM or analog front end	Check all connections in the sensing head.
0004	EEPROM checksum fault	Error reading EEPROM	Replace sensor module.
0008	Zero adjust out of range	Field zero adjustment exceeds limits	Perform zero adjustment
0010	Span adjustment out of range	Field span adjustment exceeds limits	Perform span adjustment
0020	Input voltage fault	Power supply voltage out of range	Call service
0040	Microprocessor fault	MPU clock fault	Call service
0080	Software fault	Firmware error	Power-cycle. If it re-occurs then call service
0100	RS485 receiver fault	Receiver buffer full (message too long to receive buffer)	Power-cycle. If it re-occurs then call service
0200	RS485 checksum fault	Checksum error in received packet	Power-cycle. If it re-occurs then call service
0400	Modbus fault	Packet timeout. Modbus message truncated or timed out early	Power-cycle. If it re-occurs then call service
0800	Temperature sensor fault	Temperature sensor disconnected or no valid reading	Check connection to sensor PCB
1000	Temperature out of range fault	Temperature out of range	Confirm that sensing head is operating within specifications
2000	Analog front end communications fault	EC analog front end failure	Replace sensor module
4000	Negative gas concentration fault	Sensor has drifted too negative	Perform zero and span calibration
8000	Sensor configuration fault	General error in sensor configuration	Replace sensor module

5.4 Sensor Maintenance (General Purpose Housings)

5.4.1 Components Overview



CAUTION

This product uses semiconductors which can be damaged by electrostatic discharge (ESD). When handling the PCB, care must be taken so that the electronics is not damaged.



NOTICE

If the instrument has two sensors installed, and both sensors, modules or heads should be replaced, then replace and register them one at a time. Failing to do so might cause a fault. Observe the sensor type (target gas, measuring range) and replace the sensor with the same type.

If sensors should be replaced with different types, be sure to de-register the sensor(s) first, and then register them one at a time. Refer to the following sections:

- 4.3.8: De-register All Sensors and Reset Node Address (F-08) on page 27
- 4.3.7: De-register One Sensor (F-07) on page 27
- 4.3.6: Register Sensor (F-06) on page 26.

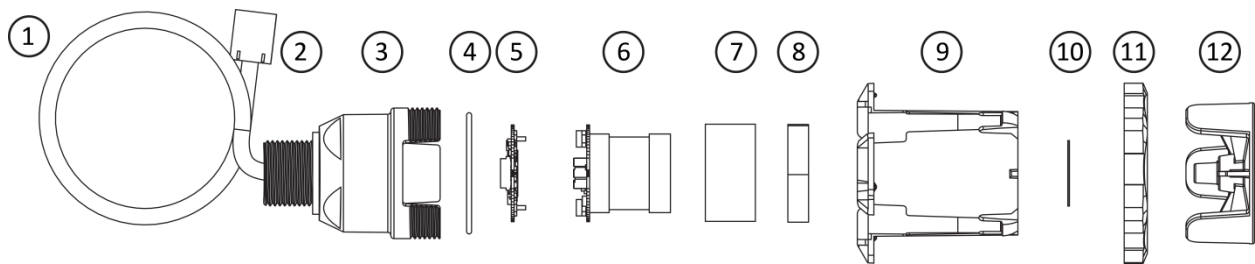

Item	Description	Replacement Instructions
1	Sensor cable	See figure above
2	Sensor connector	See figure above
3	Sensing head base	See figure above
4	O-ring	See figure above
5	Sensor control board	5.4.3: Replacing the Sensor Control Board on page 46
6	Sensor module (sensor plus PCB)	5.4.2: Replacing the Sensor Module on page 45
7	Optional spacer	See figure above (used with SC combustible and SC VOC sensors)
8	Foam sensor gasket	See figure above
9	Sensing head cap	See figure above
10	Permeable membrane	See figure above
11	Lock nut (M40 X 1.5)	See figure above
12	Splash guard	See figure above
1-12	Entire Assy (Local)	5.4.4: Replacing the Local Sensing Head Assembly on page 47
1-12	Entire Assy (Remote)	5.4.6: Replacing the Remote Sensing Head Assembly on page 49

5.4.2 Replacing the Sensor Module

See illustration in section 5.4.1: Components Overview on page 44.

Step	Description
1	Power down the instrument.
2	Unscrew M40 locknut (item 10).
3	Pull sensor cap (item 9) down.
4	Remove sensor spacer (optional on certain sensors) if it is in place.
5	Remove foam gasket (item 8) if it is adhered to the sensor module.
6	Remove the sensor module (item 6) from sensor control board (item 5).
7	With flat edges of PCBs aligned, plug new sensor module into sensor control board.
8	Ensure that the spacer (optional item 7 on certain sensors), is in place (if applicable).
9	Ensure that the round foam gasket is in place and not deformed.
10	Slide the sensing head cap back on the sensing head base.
11	Ensure that O-Ring (item 4) is in place.
12	Screw locknut back on until it clicks three times (hand tight) while compressing the sensor cap against the base.
13	Power-up the instrument.
14	Verify calibration.

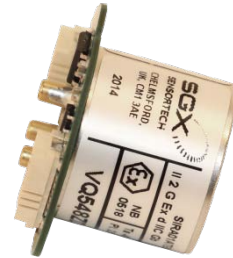

MGS-550 Fixed Gas Detector

5.4.3 Replacing the Sensor Control Board



See illustration in section 5.4.1: Components Overview on page 44.

Step	Description
1	Power down the instrument.
2	Unscrew M40 locknut (item 10).
3	Pull sensor cap (item 8) down.
4	Remove sensor spacer (optional on certain sensors) , if it is in place (if applicable).
5	Remove foam gasket (item 7) if it is adhered to the sensor module.
6	Pull out sensor and PCB stack (items 5 and 6) from the sensing head base (item 3).
7	Remove sensor control board (item 5) from sensor module (item 6).
8	With flat edges of PCBs aligned, plug new sensor module into sensor control board.
9	Plug PCB stack with sensor back into sensing head base.
10	Ensure that the spacer (optional on certain sensors) is in place (if applicable).
11	Ensure that the round foam gasket is in place and not deformed.
12	Slide the sensing head cap back on the sensing head base.
13	Ensure that O-Ring (item 4) is in place.
14	Screw locknut back on until it clicks three times (hand tight) while compressing the sensor cap against the base.
15	Power-up the instrument. Replacing the sensor control board requires sensor registration. See section 4.3.6: Register Sensor (F-06) on page 26.
16	Verify calibration.

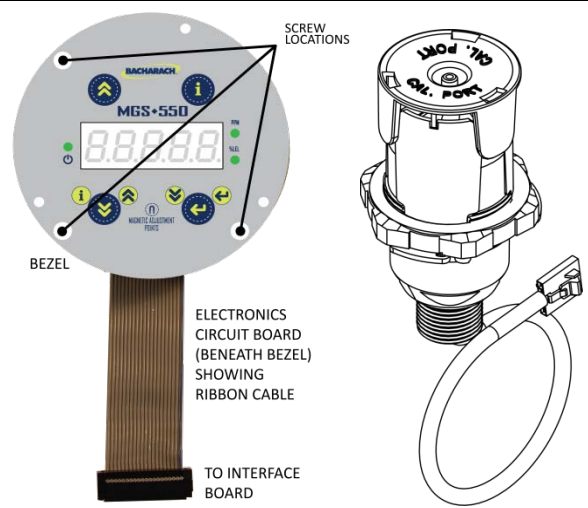
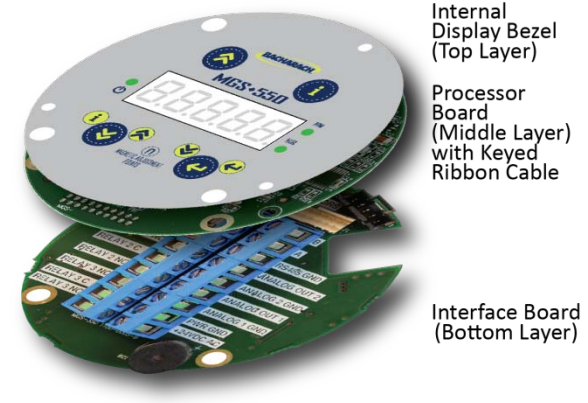

5.4.4 Replacing the Local Sensing Head Assembly

See illustration in section 5.4.1: Components Overview on page 44.

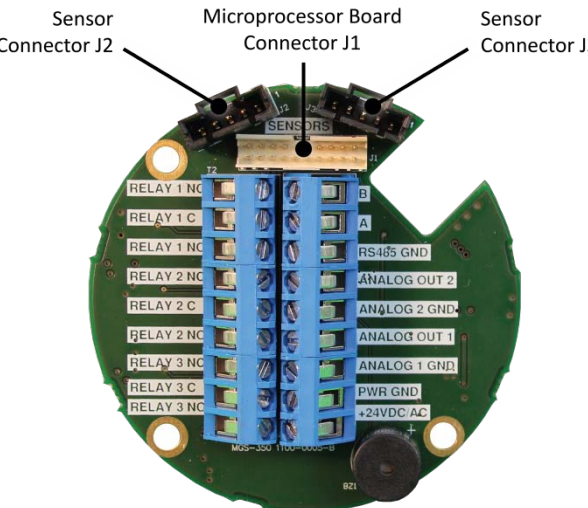
Step	Description	Description
1	Deregister the old sensor (see section 4.3.7: De-register One Sensor (F-07) on page 27).	
2	Power down the instrument.	
3	Loosen the four screws of the lid using an M5 hex key and remove the lid.	
4	Using a flat-head screwdriver, loosen the three screws and carefully pull out the bezel from the enclosure.	
5	Unplug the old sensing head.	
6	Unscrew the old sensing head.	
7	Screw sensing head with attached gasket into the housing and tighten (maintain IP rating).	
8	Plug new sensing head connector into socket.	 <p>Internal Display Bezel (Top Layer)</p> <p>Processor Board (Middle Layer) with Keyed Ribbon Cable</p>
9	Place bezel back into the enclosure and secure with the three screws to the standoffs.	
10	Put lid back on and tighten the four screws.	
11	Power-up instrument.	
12	<p>The instrument will prompt to start the sensor registration (e.g., “rEg 1”). Acknowledge with [ENTER]. The instrument will then indicate successful registration (e.g., “PASS 1”).</p> 	 <p>Sensor Connector J2</p> <p>Microprocessor Board Connector J1</p> <p>Sensor Connector J3</p> <p>RELAY 1 NC</p> <p>RELAY 1 C</p> <p>RELAY 2 NC</p> <p>RELAY 2 C</p> <p>RELAY 3 NC</p> <p>RELAY 3 C</p> <p>RS485 GND</p> <p>ANALOG OUT 2</p> <p>ANALOG 2 GND</p> <p>ANALOG OUT 1</p> <p>ANALOG 1 GND</p> <p>PWR GND</p> <p>+24VDC/AC</p>

MGS-550 Fixed Gas Detector

5.4.5 Adding a Second Sensor



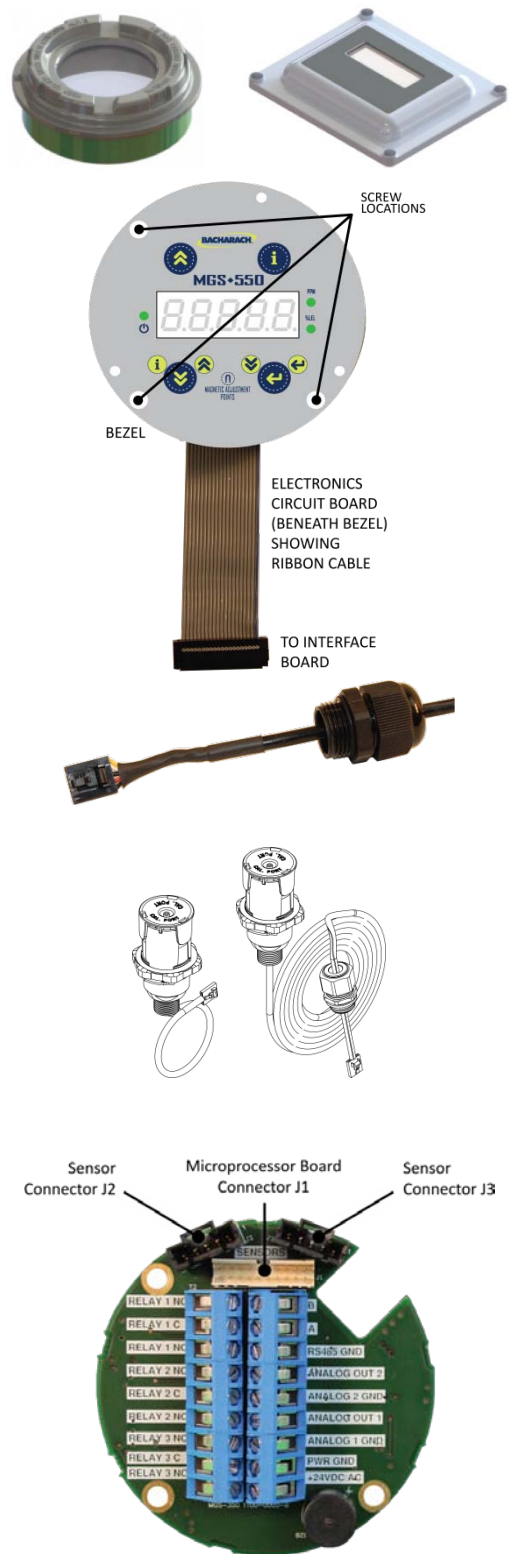

Step	Description
1	Power down the instrument.
2	Open the housing. For the GP housing: <ul style="list-style-type: none"> Loosen the four screws of the lid using an M5 hex key and remove the lid.
3	Using a flat-head screwdriver, loosen the three screws and carefully pull out the bezel from the enclosure.
4	Remove an unused plug from the enclosure, if necessary.
5	Feed the connector end of the sensor assembly into the enclosure.
6	For the GP housing: <ul style="list-style-type: none"> Screw cable gland with attached gasket into the housing and tighten (maintain IP rating).
7	Plug the new sensing head connector into the open sensor connector socket on the interface board.
8	Place the bezel back into the enclosure and secure with the three screws to the standoffs.
9	Replace the enclosure lid as appropriate.
10	Power-up the instrument.
11	The instrument will prompt to start the sensor registration (e.g., "rEg 2"). Acknowledge with [ENTER]. The instrument will then indicate successful registration (e.g., "PASS 2").

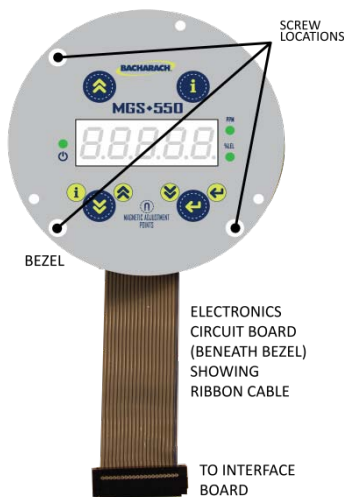
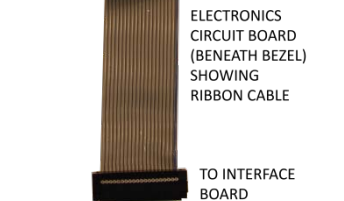
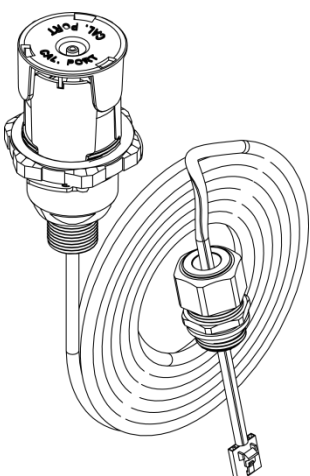

8.8.8.8.
P.A.S.S.2.

5.4.6 Replacing the Remote Sensing Head Assembly

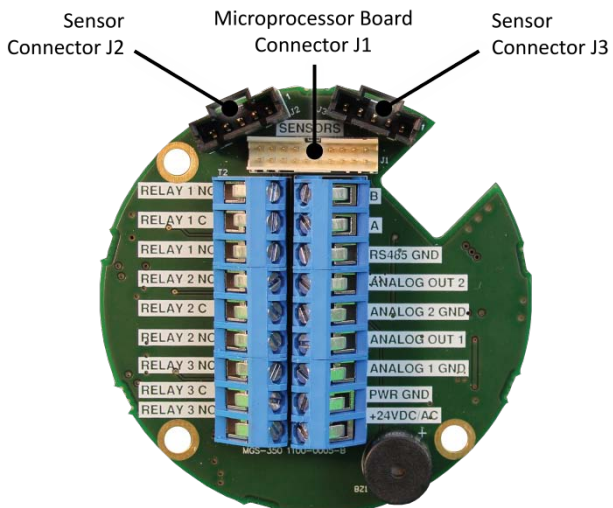
See illustration in section 5.4.1: Components Overview on page 44.

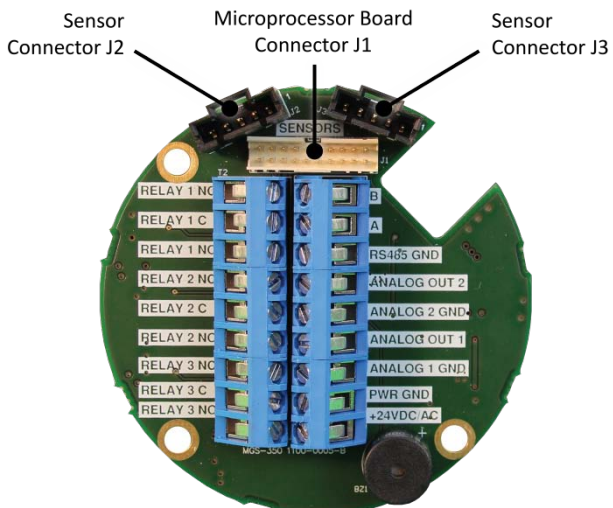
Step	Description	Description
1	Power down the instrument.	
2	Loosen the four screws of the lid using an M5 hex key and remove the lid.	
3	Using a flat-head screwdriver, loosen the three screws and carefully pull out the bezel from the enclosure.	
4	Unplug the old sensing head.	
5	Unscrew cable gland of old sensing head and remove.	
6	Screw cable gland into the housing and tighten (maintain IP rating).	
7	Plug new sensing head connector into socket.	
8	Place bezel back into the enclosure and secure with the three screws to the standoffs.	
9	Put lid back on and tighten the four screws.	
10	Power-up instrument.	
11	<p>The instrument will prompt to start the sensor registration (e.g., "rEg 1"). Acknowledge with [ENTER]. The instrument will then indicate successful registration (e.g., "PASS 1").</p> 	

5.5 Sensor Maintenance (Explosion Proof Housings)

5.5.1 Components Overview



CAUTION

This product uses semiconductors which can be damaged by electrostatic discharge (ESD). When handling the PCB, care must be taken so that the electronics is not damaged.



NOTICE

If the instrument has two sensors installed, and both sensors, modules or heads are to be replaced, then replace and register them one at a time. Failing to do so might cause a fault. Observe the sensor type (target gas, measuring range) and replace the sensor with the same type.

If sensors are to be replaced with different types, be sure to de-register the sensor(s) first, and then register them one at a time. Refer to the following sections:

- 4.3.8: De-register All Sensors and Reset Node Address (F-08) on page 27
- 4.3.7: De-register One Sensor (F-07) on page 27
- 4.3.6: Register Sensor (F-06) on page 26.

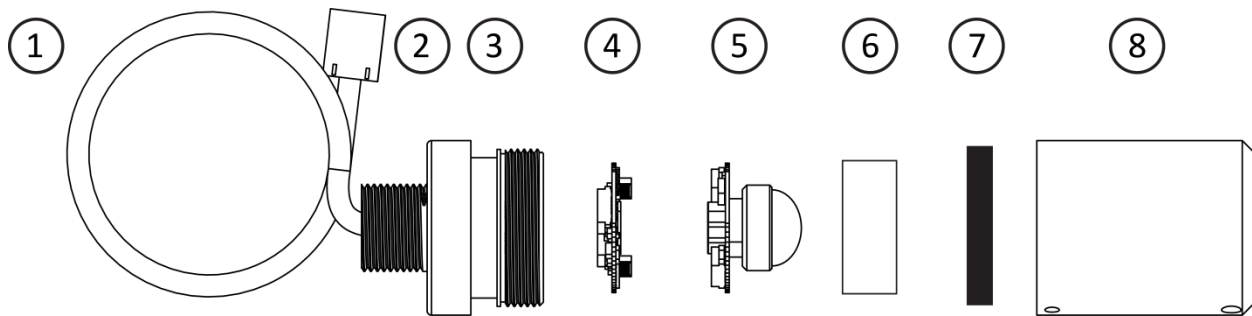

Item	Description	Replacement Instructions
1	Sensor cable	See figure above
2	Sensor connector	See figure above
3	Sensing head base	See figure above
4	Sensor control board	5.5.3: Replacing the Sensor Control Board on page 52
5	Sensor module (sensor plus PCB)	5.5.2: Replacing the Sensor Module on page 51
6	Optional spacer	See figure above (optional)
7	Foam piece	See figure above
8	Sensing head cap	See figure above
1-8	Entire Assy (Local)	5.5.4: Replacing the Local Sensing Head Assembly on page 53
1-8	Entire Assy (Remote)	5.5.5: Replacing the Remote Sensing Head Assembly on page 54



5.5.2 Replacing the Sensor Module

See illustration in section 5.5.1: Components Overview on page 50.

Step	Description	Description
1	Power down the instrument.	
2	Loosen the set screw (see photos to right) in the sensing head cap (item 8) using a 1.5 mm hex wrench.	
3	Unscrew the sensing head cap (item 8) and remove.	
4	Pull out sensor module (item 5) from sensor control board (item 4).	
5	With flat edges of PCBs aligned, plug new sensor module into sensor control board.	
6	Screw on the sensing head cap to the sensing head base (hand tight).	
7	Tighten the set screw in the sensing head cap.	
8	Power-up the instrument.	
9	Verify calibration.	

5.5.4 Replacing the Local Sensing Head Assembly

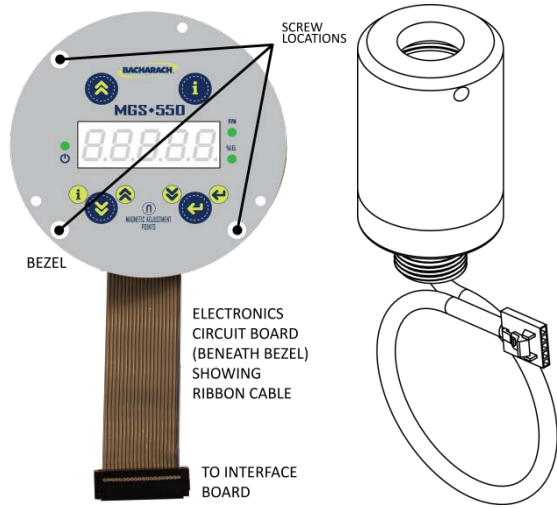
See illustration in section 5.5.1: Components Overview on page 50.

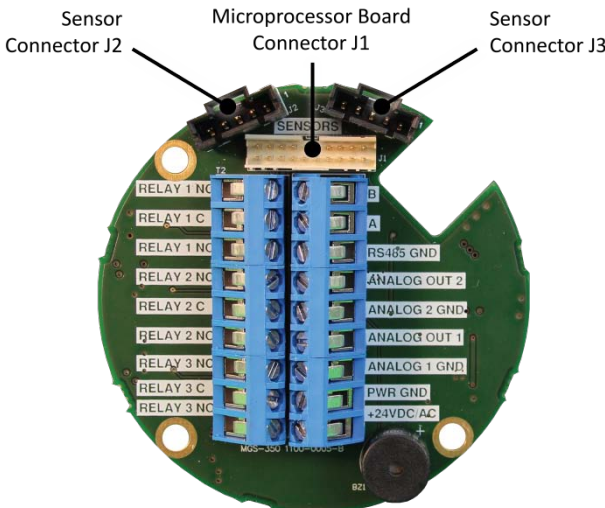
Step	Description	Description
1	Power down the instrument.	
2	Loosen the set-screw (1.5 mm hex key) and unscrew lid from instrument.	
3	Using a flat-head screwdriver, loosen the three screws and carefully pull out the bezel from the enclosure.	
4	Unplug the old sensing head.	
5	Unscrew the old sensing head.	
6	Screw sensing head into the housing and tighten (maintain Ex d rating).	
7	Plug new sensing head connector into socket.	
8	Place bezel back into the enclosure and secure with the three screws to the standoffs.	
9	Screw on lid until it is seated, then tighten the set-screw (maintain Ex d rating).	
10	Power-up instrument.	
11	<p>The instrument will prompt to start the sensor registration (e.g., "rEg 1"). Acknowledge with [ENTER]. The instrument will then indicate successful registration (e.g., "PASS 1").</p> 	

MGS-550 Fixed Gas Detector

5.5.5 Replacing the Remote Sensing Head Assembly

See illustration in section 5.5.1: Components Overview on page 50.

Step	Description
1	Power down the instrument.
2	Loosen the set-screw (1.5 mm hex key) and unscrew lid from instrument.
3	Using a flat-head screwdriver, loosen the three screws and carefully pull out the bezel from the enclosure.
4	Unplug the old sensing head.
5	Unscrew old remote XP sensing head from conduit to facilitate removal of old sensing head assembly.
6	Feed the connector end of the new remote XP sensing head through the conduit. Depending on the conduit that was used during installation, you may need to partially disassemble the conduit.
7	Screw the sensor end of the XP sensing head assembly into remote end of the conduit.
8	Plug new sensing head connector into the socket on the interface board.
9	Place bezel back into the enclosure and secure with the three screws to the standoffs.
10	Screw on lid until it is seated, then tighten the set-screw (maintain Ex d rating).
11	Power-up the instrument.
12	The instrument will prompt to start the sensor registration (e.g., "rEg 1"). Acknowledge with [ENTER]. The instrument will then indicate successful registration (e.g., "PASS 1").

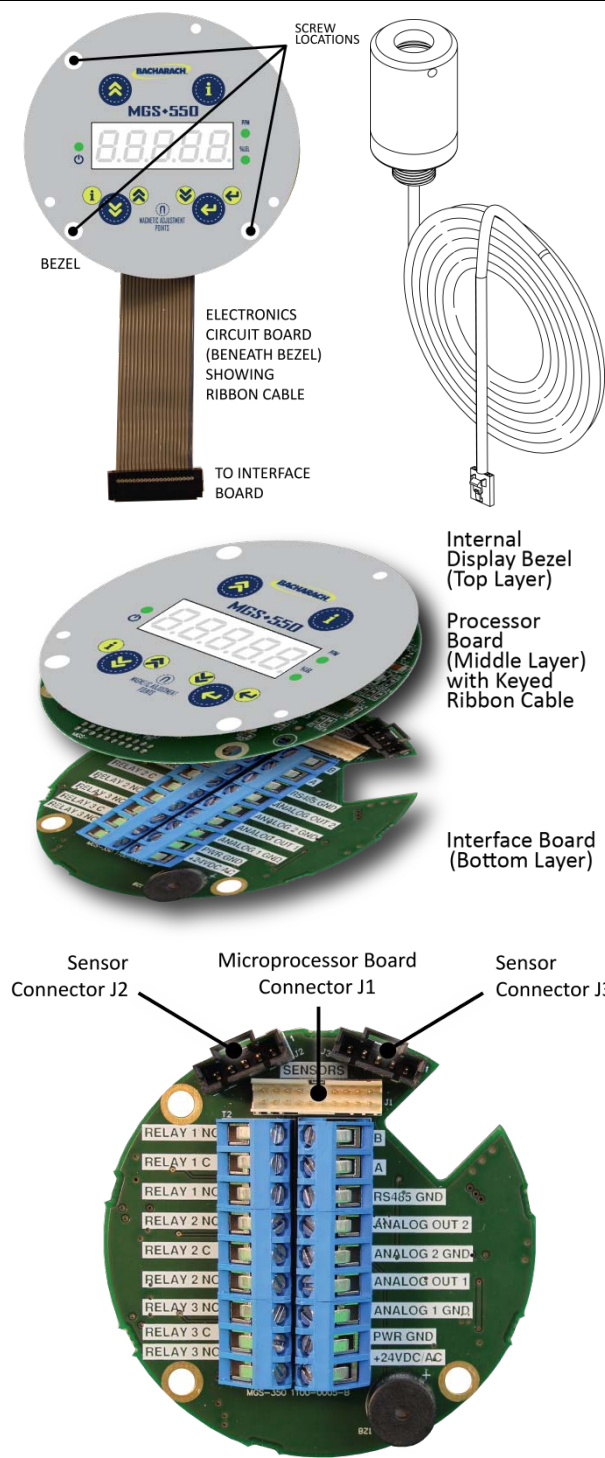

5.6 Replacing the Instrument Electronics



CAUTION

This product uses semiconductors which can be damaged by electrostatic discharge (ESD). When handling the PCB, care must be taken so that the electronics are not damaged.

Step	Description	
1	The user should note parameters, settings such as alarm setpoints, relay configurations, etc., as the unit will have factory settings after replacement of the processor board	
2	Power down the instrument.	
3	Remove the housing lid. <ul style="list-style-type: none"> For general purpose (GP) enclosure, loosen the four screws of the lid using an M5 hex key and remove the lid. For the explosion proof (XP) enclosure, loosen the set-screw (1.5 mm hex key) and unscrew lid from instrument. 	
4	Using a flat-head screwdriver, loosen the three screws and carefully pull out the bezel and Processor Board (as one unit) from the enclosure.	
5	Unplug ribbon cable from Interface Board.	<p>Internal Display Bezel (Top Layer)</p> <p>Processor Board (Middle Layer) with Keyed Ribbon Cable</p> <p>Interface Board (Bottom Layer)</p>
6	Remove the bezel from the processor Board.	
7	Attach bezel to new Processor Board.	
8	Plug ribbon cable of new Processor Board into socket of Interface Board.	
9	Place bezel (and attached Processor Board) back into the enclosure and secure with the three screws to the standoffs.	
10	Power-up instrument.	
11	Register the sensor(s) (both sequentially, if applicable). See section 4.3.6: Register Sensor (F-06) on page 26.	
12	Place bezel back into the enclosure and secure with the three screws to the standoffs.	
13	Replace the housing lid (maintain IP or Ex d rating). <ul style="list-style-type: none"> For general purpose (GP) enclosure, tighten the four screws of the lid using an M5 hex key. For the explosion proof (XP) enclosure, screw on the lid until it is seated, then tighten the set-screw (1.5 mm hex key). 	
14	Check settings of the parameters (see section 4.4: Parameters on page 29), perform an instrument test (see section 4.3.4: Instrument Test (F-04) on page 25), and check calibration (see section 5.2.4: Span Adjustment on page 38).	

5.7 Replacing the Interface Board



This product uses semiconductors which can be damaged by electrostatic discharge (ESD). When handling the PCB, care must be taken so that the electronics are not damaged.

Step	Description
1	Power down the instrument.
2	Remove the housing lid. <ul style="list-style-type: none"> For general purpose (GP) enclosure, loosen the four screws of the lid using an M5 hex key and remove the lid. For the explosion proof (XP) enclosure, loosen the set-screw (1.5 mm hex key) and unscrew lid from instrument.
3	Using a flat-head screwdriver, loosen the three screws and carefully pull out the bezel and Processor Board (as one unit) from the enclosure.
4	Unplug ribbon cable from Interface Board.
5	Label all connected wires, then disconnect all interface board wiring.
6	Using a Philip's-head screwdriver, loosen the screws that hold the Interface Board in place. For the XP enclosure, you must loosen the standoffs to remove the Interface Board. Remove the Interface Board from the enclosure.
7	Replace the old Interface Board with the new one.
8	Secure the Interface Board to the enclosure by reversing the previous removal procedure.
9	With the Interface Board in place, and the standoffs secured, re-attach the wiring using the labels from the earlier step.
10	Place bezel and Processor Board back into the enclosure and secure with the three screws to the standoffs.
11	Replace the housing lid (maintain IP or Ex d rating). <ul style="list-style-type: none"> For general purpose (GP) enclosure, tighten the four screws of the lid using an M5 hex key. For the explosion proof (XP) enclosure, screw on the lid until it is seated, then tighten the set-screw (1.5 mm hex key).
12	Power up the instrument and verify proper operation.

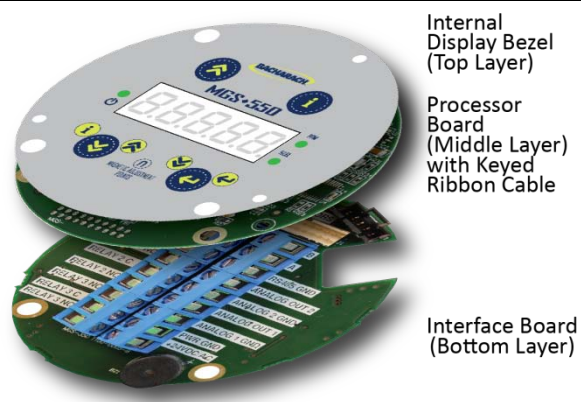

5.8 Cleaning the Instrument

Clean the instrument with a soft cloth using water and a mild detergent. Rinse with water.

SECTION 6. FACTORY DEFAULT SETTINGS

Parameter	Name	Factory Default	Changed To
S1-01	Sensor 1 Gas Name	Sensor dependent	
S1-02	Sensor 1 UID	5-digits, alphanumeric	
S1-03	Sensor 1 Low Alarm ppb/ppm/%LEL/Vol%	Sensor dependent	
S1-04	Sensor 1 Medium Alarm ppb/ppm/%LEL/Vol%	Sensor dependent	
S1-05	Sensor 1 High Alarm ppb/ppm/%LEL/Vol%	Sensor dependent	
S1-06	Sensor 1 Low Alarm Behavior	2 = non-latching, acknowledgeable	
S1-07	Sensor 1 Medium Alarm Behavior	3 = latching, not acknowledgeable	
S1-08	Sensor 1 High Alarm Behavior	3 = latching, not acknowledgeable	
S1-09	Sensor 1 Type Code	4-digit, alphanumeric	
S1-10	Sensor 1 Units	Sensor dependent	
S1-11	Sensor 1 Full Scale	Sensor dependent	
S1-12	Sensor 1 Test Flag	0 = sensor OK	
S2-01	Sensor 2 Gas Name	Sensor dependent	
S2-02	Sensor 2 UID	5-digits, alphanumeric	
S2-03	Sensor 2 Low Alarm ppb/ppm/%LEL/Vol%	Sensor dependent	
S2-04	Sensor 2 Medium Alarm ppb/ppm/%LEL/Vol%	Sensor dependent	
S2-05	Sensor 2 High Alarm ppb/ppm/%LEL/Vol%	Sensor dependent	
S2-06	Sensor 2 Low Alarm Behavior	2 = non-latching, acknowledgeable	
S2-07	Sensor 2 Medium Alarm Behavior	3 = latching, not acknowledgeable	
S2-08	Sensor 2 High Alarm Behavior	3 = latching, not acknowledgeable	
S2-09	Sensor 2 Type Code	4-digit, alphanumeric	
S2-10	Sensor 2 Units	Sensor dependent	
S2-11	Sensor 2 Full Scale	Sensor dependent	
S2-12	Sensor 2 Test Flag	0 = sensor OK	
R1-01	Relay 1 Contact Behavior / Failsafe	0 = normally open	
R1-02	Relay 1 Source	1-Sensor system = 01	
R2-01	Relay 2 Contact Behavior / Failsafe	0 = normally open	
R2-02	Relay 2 Source	1-Sensor system = 02	

MGS-550 Fixed Gas Detector

Parameter	Name	Factory Default	Changed To
R3-01	Relay 3 Contact Behavior / Failsafe	0 = normally open	
R3-02	Relay 3 Source	1-Sensor system = 04	
AF-01	Alarm ON Delay Value	00 = no delay	
AF-02	Alarm OFF Delay Value	00 = no delay	
AF-03	Critical Fault Latching	1 = latching	
AF-04	Alarm Acknowledge Timeout	59 minutes	
A1-01	Analog Output 1 Source	1 = Sensor 1	
A1-02	Analog Output 1 Type	4 = 4 – 20 mA	
A1-03	Analog Output 1 Scaling	100% = full scale	
A1-04	Analog Output 1 Offset	0 = no offset	
A2-01	Analog Output 2 Source	1 = Sensor 1	
A2-02	Analog Output 2 Type	4 = 4 – 20 mA	
A2-03	Analog Output 2 Scaling	100% = full scale	
A2-04	Analog Output 2 Offset	0 = no offset	
MB-01	Modbus Node Address	001	
MB-02	RS-485 Baud Rate	0 = 9600	
MB-03	RS-485 Stop Bits	1	
MB-04	RS-485 Parity	0 = None	
MB-05	Modbus slave termination	0 = Out	
P1-01	Display Mode	1 = On	
B1-01	Buzzer enable and source	14 = any alarm or sensor fault or critical instrument fault	

SECTION 7. SENSOR PRINCIPLE

7.1 Electrochemical Sensors

Electrochemical sensors measure the partial pressure of gases under atmospheric conditions. The monitored ambient air diffuses through a membrane into the liquid electrolyte in the sensor. The electrolyte contains a measuring electrode, a counter-electrode and a reference electrode. An electronic “potentiostat” circuit ensures a constant electrical voltage between measuring electrode and reference electrode. Voltage, electrolyte, and electrode material are selected to suit the gas being monitored so that it is transformed electrochemically on the measuring electrode and a current flows through the sensor. This current is proportional to the gas concentration. At the same time, oxygen from the ambient air reacts at the counter electrode electrochemically. The current flowing through the sensor is amplified electronically, digitized and corrected for several parameters (e.g., the ambient temperature).

7.2 Catalytic Bead Sensors

A catalytic bead sensor measures the partial pressure of combustible gases and vapors in ambient air. It uses the heat-of-combustion principle.

The monitored air diffuses through the sintered metal disc into the sensor. The mixture of combustible gases, vapors, and air are catalytically combusted at a heated detector element (called a *pellistor*). The oxygen content in the air must be greater than 12 Vol%. Due to the resulting heat-of-combustion, the temperature of the detector element rises. This increase in temperature causes a change of resistance in the detector element, which is proportional to the concentration of the mixture of combustible gases and vapors in the monitored air. In addition to the catalytically active detector element, there is a compensator element. Both elements are parts of a Wheatstone bridge. Thus environmental effects like changes in ambient temperature or humidity are almost entirely compensated.

**NOTICE**

Certain substances in the atmosphere to be monitored may impair the sensitivity of the sensors. Such substances include, but are not limited to:

1. Polymerizing substances such as acrylonitrile, butadiene and styrene,
2. Corrosive compounds such as halogenated hydrocarbons (releasing halogens such as bromine, chlorine or fluorine when oxidized) and halogen hydride acids as well as acidic gaseous compounds such as sulfur dioxide and nitrogen oxides,
3. Catalyst poisons such as sulfurous and phosphorous compounds, silicon compounds (especially silicones), and metal-organic vapors.

It may be necessary to check the calibration if the sensor has been exposed for a long time to a high concentration of flammable gases, vapors, or the above-mentioned contaminating substances.

7.3 Semiconductor Sensors

Semiconductor or metallic oxide sensors (MOSs) are among the most versatile of all broad-range sensors. They can be used to detect a variety of gases and vapors in low ppm or even combustible ranges. The sensor is made up of a mixture of metallic oxides. They are heated to a temperature between 150° and 300° C depending on the gas(es) to be detected. The temperature of operation as well as the “recipe” of mixed oxides determines the sensor selectivity to various toxic gases, vapors, and refrigerants. Electrical conductivity greatly increases as soon as a diffusion process allows the gas or vapor molecules to come in contact with the sensor surface. Water vapor, high ambient humidity, temperature fluctuations, and low oxygen levels can result in higher readings.



NOTICE

Certain substances in the environment to be monitored may impair the sensitivity of the sensors:

1. Materials containing silicone or silicone rubber/putty
 2. Corrosive gases such as hydrogen sulfide, sulfur oxide, chlorine, hydrogen chloride, etc.
 3. Alkaline metals, salt water spray.
-

7.4 Infrared Sensors

The infrared (IR) gas sensor is designed to measure the concentration of combustible gases and vapors in the ambient air. The sensor principle is based on the concentration-dependent absorption of infrared radiation in measured gases.

The monitored ambient air diffuses through a sintered metal material into the housing of an optical “bench”. The broadband light emitted by an IR source passes through the gas in the optical bench and is reflected by the walls from where it is directed towards a dual-element detector. One channel of the detector measures the gas-dependent light transmission, while the other channel is used as a reference. The ratio between measurement and reference signal is used to determine the gas concentration. Internal electronics and software calculate the concentration and produce an output signal.

SECTION 8. DISPOSING OF THE INSTRUMENT

8.1 Disposing of Electrical and Electronic Equipment

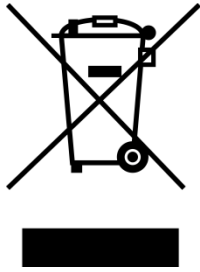

EU-wide regulations governing the disposal of electrical and electronic appliances which have been defined in the EU Directive 2012/19/EU and in national laws have been effective since August 2012 and apply to this device.

Common household appliances can be disposed of using special collecting and recycling facilities. However, this device has not been registered for household usage. Therefore it must not be disposed of through these channels. The device can be returned to your national Bacharach Sales Organization for disposal. Please do not hesitate to contact Bacharach if you have any further questions on this issue.

8.2 Disposing of Electrochemical Sensors

Dispose of sensors in accordance with local laws.



WARNING

EXPLOSION DANGER! Do not dispose of sensors in fire due to the risk of explosion and resulting chemical burns.



WARNING

Do not force open electrochemical sensors.





WARNING

Observe the applicable local waste disposal regulations. For information, consult your local environmental agency, local government offices or appropriate waste disposal companies.

SECTION 9. TECHNICAL DATA

9.1 General Specifications

Category	Specifications	
Signals to Central Controller	Analog Current	Normal operation:4 to 20 mA
		Drift below zero:3.8 mA
		Measuring range exceeded:20.5 mA
		Instrument fault:≤ 1.2 mA
		Fault on analog interface:> 21 mA
		Offline mode/Maintenance signal:3 mA steady signal
	Analog Voltage	0 to 5 V; 1 to 5 V; 0 to 10 V; 2 to 10 V (selectable) During fault condition, 1 to 5 V and 2 to 10 V outputs are 0 V.
	Modbus RTU over RS-485	Baud rate:..... 9,600 or 19,200 (selectable)
		Start bits: 1
		Data bits: 8
		Parity: None, odd, even (selectable)
		Stop bits: 1 or 2 (selectable)
Retry time:..... 500 ms, min time between retries		
End of message: Silent 3.5 characters		
Power Supply and Relays	Operating voltage	19.5 to 28.5 VDC; 24 VAC ± 20%, 50/60 Hz
	Power Monitoring	Green LED
	Inrush current	1.5 A
	Operating current, max.	0.25 mA at 24 VDC
	Relay rating	3 SPDT, arbitrary designation 1 A at 24 VAC/VDC, 0.5 A at 125 VAC, resistive load
	Audible alarm	Internal Buzzer ≥85 dB at 4" (10 cm); open enclosure
	Alarm delay	0 to 15 minutes (selectable)
Wiring	Power and analog signal	2-, 3-, 4-, or 6-core shielded cable, 16 to 20 AWG (0.5 to 1.5 mm ²)
	Modbus network	2-core twisted pair shielded cable 16 to 20 AWG (0.5 to 1.5 mm ²) with 120 Ohm characteristic impedance
	Cable gland	M20x1.5, 0.24" to 0.47" (6 to 12 mm) outer cable diameter
Physical Specifications	Enclosure and sensor housing	General Purpose (GP): ABS Explosion Proof (XP): Aluminum
	Enclosure protection	IP66
	Display	5 digit, 7 segment LED
	Enclosure Size (WxHxD) (Approx.)	General Purpose (GP): 210x225x85 mm (8.3x8.9x3.1 in) Explosion Proof (XP): 125x190x90 mm (4.9x7.5x3.5 in)
	Weight (Approx.)	General Purpose (GP): 1 kg (2 lbs) Explosion Proof (XP): 1.6 kg (3.5 lbs)

Category	Specifications	
Environmental	Temperature	- 40 to 120 °F (-40 to 50 °C)
	Storage temperature	- 5 to 100 °F (-20 to 40 °C)
	Humidity	5 to 90 %RH, non-condensing
	Pressure	20.7 to 38.4 in. of Hg (700 to 1300 hPa)
	Elevation	0 to 10,000 ft. (3050 m) altitude
	Sensors	See Section 9.2: Sensor Specifications on page 63.
	Influences	For influences on the measurement performance and restrictions of a particular sensor see sensor data sheet.
Agency Approvals	CE, UL/CSA/IEC/EN 61010-1	
Certifications	For instruments assembled in USA: TÜV-SÜD For instruments assembled in Ireland: NSAI	 

9.2 Sensor Specifications

Sensor Information	Electro-Chemical (EC)	Semi-Conductor (SC)	Catalytic Bead (CAT)	Infrared (IR)
Sensor Life (Typical)	2 to 3 years	5 to 8 years	5 years	5 years
Temperature Range	-20° to 40° C -40° to 40° C ¹	-40° to 50° C	-40° to 50° C	-40° to 50° C
	-4° to 104° F -40° to 104° F ¹	-40° to 122° F	-40° to 122° F	-40° to 122° F

EC Sensors	Formula	Measuring Range(s)
Ammonia	NH ₃	0 to 100, 0 to 1,000, 0 to 5,000 ppm
Carbon Monoxide	CO	0 to 1,000 ppm
Chlorine ²	Cl ₂	0 to 10 ppm
Fluorine ²	F ₂	0 to 1 ppm
Hydrogen	H ₂	0 to 10,000 ppm
Hydrogen Chloride ²	HCl	0 to 10 ppm
Hydrogen Cyanide	HCN	0 to 30 ppm
Hydrogen Sulfide	H ₂ S	0 to 100 ppm
Nitrogen Dioxide	NO ₂	0 to 20 ppm
Oxygen	O ₂	0 to 30 Vol%
Ozone ²	O ₃	0 to 1 ppm
Sulfur Dioxide	SO ₂	0 to 10 ppm

¹ For NH₃ sensor 0 to 100 ppm and 0 to 1,000 ppm only.

² No IP rating; not available in Ex d

MGS-550 Fixed Gas Detector

IR Sensors	Formula	Measuring Range
Carbon Dioxide	CO ₂	0 to 5,000 ppm = 0 to 0.5 Vol% 0 to 10,000 ppm = 0 to 1 Vol% 0 to 20,000 ppm = 0 to 2 Vol% 0 to 30,000 ppm = 0 to 3 Vol% 0 to 40,000 ppm = 0 to 4 Vol% 0 to 50,000 ppm = 0 to 5 Vol%
Hydrocarbons (Butane, Methane, and Propane)	C ₄ H ₁₀	0 to 100 %LEL
	CH ₄	0 to 100 %LEL
	C ₃ H ₈	0 to 100 %LEL

CAT Sensors	Formula	Measuring Range
Combustible Gasses (including Ammonia)	Various	0 to 100 %LEL

SC Sensors	Typical Example Gases	Measuring Range
HFCs	R134a, R404A, R407C, R410A, R507	0 to 1,000, 0 to 10,000 ppm
HCFCs and HFOs	R22	0 to 1,000, 0 to 10,000 ppm
	R1234YF	0 to 1,000 ppm
	R1234ZE	0 to 1,000, 0 to 10,000 ppm
Hydrocarbons	Methane (Natural gas), Propane, Butane, Iso-Butane, Ethylene	0 to 5,000 ppm (SC Ethylene is 0 to 2,000 ppm)
Ammonia	NH ₃	0 to 10,000 ppm
Hydrogen	H ₂	0 to 5,000 ppm
VOCs	Acetone, Chloroform, Ethanol, Methanol, Methylene Chloride, Ethylene Chloride	0 to 1,000 ppm

9.3 Modbus Registers



NOTICE

If items span two registers (e.g., 30024 and 30025), then the registers are “long” or “float” data types. Otherwise the registers are integer data types or ASCII.



NOTICE

If a sensor is not registered, then reading from a Modbus register associated with that sensor will generate a Modbus exception.

9.3.1 Analog Input Registers

Analog input registers are read only and use Modbus function code 04 (Read Input Register).

Reg	Description	Range	Units	Param
30001	16-bit Current Fault Code Instrument electronics	See 5.3.4: Non-Critical (E300) Faults on page 42 and 5.3.3 Critical Faults on page 41	-	D-01
30002	16-bit Last Fault Code Instrument electronics		-	D-02
30003	Software Version Instrument electronics	-	-	-
30004 - 30010	<i>Reserved</i>	-	-	-
30011	Sensor 1 Type Code	-	-	S1-09
30012	Display units sensor 1	1 = ppm 2 = ppb 3 = Vol% 4 = %LEL	-	S1-10
30013	Full Scale in ppb, ppm, %LEL or Vol% Sensor 1 (Note: % LEL and Vol% sensors are always displayed as "x 10" the actual value. For example, a reading of "205" is "20.5%".)	0 to 65535	Unit dependent	S1-11
30014	Sensor 1 Gas Type Text Char 1, 2	0 to 9; a to z	ASCII Text	S1-01
30015	Sensor 1 Gas Type Text Char 3, 4	0 to 9; a to z	ASCII Text	
30016	Sensor 1 Gas Type Text Char 5, NULL	0 to 9; a to z	ASCII Text	
30017	%LEL/Vol% Conversion Factor * 10 Sensor 1. This is the factor to convert the integer gas output level from %LEL or Vol% to ppm.	0 to 65535	Unit dependent	-
30018	Alarm Low Set-Point Sensor 1	0 to 100	% Full scale	S1-03
30019	Alarm Medium Set-Point Sensor 1	0 to 100	% Full scale	S1-04
30020	Alarm High Set-Point Sensor 1	0 to 100	% Full scale	S1-05
30021	Concentration ppb, ppm, %LEL or Vol% Sensor 1 (Note: % LEL and Vol% sensors are always displayed as "x 10" the actual value. For example, a reading of "205" is "20.5%".) Units are in register 30012.	0 to 65535	Unit dependent	-
30022	Concentration Sensor 1	0 to 100	% Full Scale	-
30023	Sensor timer Sensor 1	0 to 65535	Hours	-
30024	ppm Hours Sensor 1 (upper long integer)	-	ppm Hours	-
30025	ppm Hours Sensor 1 (lower long integer)			
30026	Temperature Deg C Sensor 1 Note: Sensor PCB temp, not gas temp	-40 to +80	°C	-
30027	16 bit Fault Code Sensor 1	See 5.3.5: Sensor Faults on page 42	-	D-07

MGS-550 Fixed Gas Detector

Reg	Description	Range	Units	Param
30028	Sensor 1 Instrument electronics UID Char 1,2	0 to 9; a to z	ASCII Text	S1-02
30029	Sensor 1 Instrument electronics UID Char 3,4	0 to 9; a to z	ASCII Text	
30030	Sensor 1 Instrument electronics UID Char 5,NULL	0 to 9; a to z	ASCII Text	
30031	Sensor 2 Type Code	-	-	S2-09
30032	Display units Sensor 2	1 = ppm 2 = ppb 3 = Vol% 4 = %LEL	-	S2-10
30033	Full Scale in ppb, ppm, %LEL or Vol% Sensor 2. (Note: % LEL and Vol% sensors are always displayed as "x 10" the actual value. For example, a reading of "205" is "20.5%.")	0 to 65535	Unit dependent	S2-11
30034	Sensor 2 Gas Type Text Char 1,2	0 to 9; a to z	ASCII Text	S2-01
30035	Sensor 2 Gas Type Text Char 3,4	0 to 9; a to z	ASCII Text	
30036	Sensor 2 Gas Type Text Char 5,NULL	0 to 9; a to z	ASCII Text	
30037	%LEL/Vol% Conversion Factor * 10 Sensor 2. This is the factor to convert the integer gas output level from %LEL or Vol% to ppm.	0 to 65535	Unit dependent	-
30038	Alarm Low Set-Point Sensor 2	0 to 100	% Full scale	-
30039	Alarm Medium Set-Point Sensor 2			-
30040	Alarm High Set-Point Sensor 2			-
30041	Concentration ppb, ppm, %LEL or Vol% Sensor 2. (Note: % LEL and Vol% sensors are always displayed as "x 10" the actual value. For example, a reading of "205" is "20.5%.")	0 to 65535	Unit dependent	-
30042	Concentration Sensor 2	0 to 100	% Full Scale	-
30043	Sensor timer Sensor 2	0 to 65535	Hours	-
30044	ppm Hours Sensor 2 (upper long integer)	-	ppm Hours	-
30045	ppm Hours Sensor 2 (lower long integer)			
30046	Temperature Deg C Sensor 2	-40 to +80	°C	-
30047	16-bit Fault Code Sensor 2	See 5.3.5: Sensor Faults on page 42	-	D-09
30048	Sensor 2 Instrument electronics UID Char 1,2	0 to 9; a to z	ASCII Text	S2-02
30049	Sensor 2 Instrument electronics UID Char 3,4	0 to 9; a to z	ASCII Text	
30050	Sensor 2 Instrument electronics UID Char 5,NULL	0 to 9; a to z	ASCII Text	
30051	Sensor 1 Module SID Char 1,2	0 to 9; a to z	ASCII Text	-
30052	Sensor 1 Module SID Char 3,4	0 to 9; a to z	ASCII Text	
30053	Sensor 1 Module SID Char 5,NULL	0 to 9; a to z	ASCII Text	
30054	Sensor 2 Module SID Char 1,2	0 to 9; a to z	ASCII Text	-

Reg	Description	Range	Units	Param
30055	Sensor 2 Module SID Char 3,4	0 to 9; a to z	ASCII Text	
30056	Sensor 2 Module SID Char 5,NULL	0 to 9; a to z	ASCII Text	

9.3.2 Analog Output Registers

Analog output registers are readable (using function code 03) and writable (using function code 06).

Reg	Description	Range	Units	Menu
40001	Display Mode	0=Off, 1=On	-	P1-01
40002	RS-485 Node Address	1 to 250	-	MB-01
40003	Baud Rate	0=9600, 1=19200	-	MB-02
40004	Stop Bits	1 or 2	-	MB-03
40005	Parity	0=None, 1=Odd, 2=Even	-	MB-04
40006	Alarm Delay ON Value	00 to 15	Minutes	AF-01
40007	Alarm Delay OFF Value	00 to 15	Minutes	AF-02
40008	Controller UID Char 1,2	0 to 9; a to z	ASCII Text	
40009	Controller UID Char 3,4	0 to 9; a to z	ASCII Text	
40010	Controller UID Char 5,NULL	0 to 9; a to z	ASCII Text	
40011	Sensor 1 Low Alarm ppb, ppm, %LEL or Vol%. (Note: % LEL and Vol% sensors are always displayed as "x 10" the actual value. For example, a reading of "205" is "20.5%.")	0 to sensor full scale	Unit dependent	S1-03
40012	Sensor 1 Med Alarm ppb, ppm, %LEL or Vol%. (Note: % LEL and Vol% sensors are always displayed as "x 10" the actual value. For example, a reading of "205" is "20.5%.")	0 to sensor full scale	Unit dependent	S1-04
40013	Sensor 1 High Alarm ppb, ppm, %LEL or Vol%. (Note: % LEL and Vol% sensors are always displayed as "x 10" the actual value. For example, a reading of "205" is "20.5%.")	0 to sensor full scale	Unit dependent	S1-05
40014	Sensor 1 Low Alarm Behavior			S1-06
40015	Sensor 1 Medium Behavior			S1-07
40016	Sensor 1 High Behavior			S1-08
40017	Sensor 2 Low Alarm ppb, ppm, %LEL or Vol%. (Note: % LEL and Vol% sensors are always displayed as "x 10" the actual value. For example, a reading of "205" is "20.5%.")	0 to sensor full scale	Unit dependent	S2-03
40018	Sensor 2 Med Alarm ppb, ppm, %LEL or Vol%. (Note: % LEL and Vol% sensors are always displayed as "x 10" the actual value. For example, a reading of "205" is "20.5%.")	0 to sensor full scale	Unit dependent	S2-04

MGS-550 Fixed Gas Detector

Reg	Description	Range	Units	Menu
40019	Sensor 2 High Alarm ppb, ppm, %LEL or Vol%. (Note: % LEL and Vol% sensors are always displayed as "x 10" the actual value. For example, a reading of "205" is "20.5%".)	0 to sensor full scale	Unit dependent	S2-05
40020	Sensor 2 Low Alarm Behavior			S2-06
40021	Sensor 2 Medium Behavior			S2-07
40022	Sensor 2 High Behavior			S2-08
40023	Analog Output 1 Source	1 = Sensor 1 2 = Sensor 2	-	A1-01
40024	Analog Output 1 Type	0 = 0 to 5 V 1 = 1 to 5 V 2 = 0 to 10 V 3 = 2 to 10 V 4 = 4 to 20 mA	-	A1-02
40025	Analog Output 1 Scaling	20% to 100% of full scale	%	A1-03
40026	Analog Output 1 Offset	±410 (can take an output below zero)	410 = 10% of full scale	A1-04
40027	Analog Output 1 Full Scale PPM			
40028	Analog Output 2 Source	1 = Sensor 1 2 = Sensor 2	-	A2-01
40029	Analog Output 2 Type	0 = 0 to 5 V 1 = 1 to 5 V 2 = 0 to 10 V 3 = 2 to 10 V 4 = 4 to 20 mA	-	A2-02
40030	Analog Output 2 Scaling	20% to 100% of full scale	%	A2-03
40031	Analog Output 2 Offset	±410 (can take an output below zero)	410 = 10% of full scale	A2-04
40032	Analog Output 2 Full Scale PPM			
40033	Relay 1 Contact Behavior/Failsafe	0 = NO 1 = Failsafe	-	R1-01
40034	Relay 2 Contact Behavior/Failsafe	0 = NO 1 = Failsafe	-	R2-01
40035	Relay 3 Contact Behavior/Failsafe	0 = NO 1 = Failsafe	-	R3-01
40036	Relay 1 Source	See 4.4.2: Relay Designation (RX-xx) on page 32	-	R1-02
40037	Relay 2 Source		-	R2-02
40038	Relay 3 Source		-	R3-02
40039	Buzzer enable and source	See 4.4.7: Buzzer Designation (B1-xx) on page 35	-	B1-01

Reg	Description	Range	Units	Menu
40040	Critical Fault Latch			AF-03
40041	Instrument electronics fault code	See 5.3.4: Non-Critical (E300) Faults on page 42 and 5.3.3 Critical Faults on page 41	-	D-01
40042	Instrument electronics last fault	See 5.3.4: Non-Critical (E300) Faults on page 42 and 5.3.3 Critical Faults on page 41	-	D-02
40043	Power supply voltage	15.5-28.5 VDC or 24 VAC ±20%	Volt	D-04
40044	Hours since last test sensor 1		Hours	D-05
40045	Hours since last test sensor 2		Hours	D-06
40046	<i>Reserved</i>			
40047	Instrument electronics 12V supply voltage x100			
40048	Instrument electronics 6V supply voltage x100			
40049	Instrument electronics 5.4V supply voltage x100			
40050	Instrument electronics 3.3V supply voltage x100			
40051	Instrument electronics temperature x100			
40052	Instrument electronics tact and magnetic switch state			

9.3.3 Input Status Flags

Input status flags are readable (using function code 02).

Reg	Description	Range
10001	Sensor 1 Low Alarm Flag	0 or 1 = alarm
10002	Sensor 1 Medium Alarm Flag	0 or 1 = alarm
10003	Sensor 1 High Alarm Flag	0 or 1 = alarm
10004	Sensor 1 Fault	0 or 1 = fault
10005	Sensor 1 Saturation Overflow	0 or 1 = gas > full scale
10006	Sensor 1 Saturation Underflow	0 or 1 = gas < 0
10007	Sensor 1 Start-up	0 or 1 = start-up
10008 - 10010	<i>Reserved</i>	
10011	Sensor 2 Low Alarm Flag	0 or 1 = alarm
10012	Sensor 2 Medium Alarm Flag	0 or 1 = alarm
10013	Sensor 2 High Alarm Flag	0 or 1 = alarm
10014	Sensor 2 Fault	0 or 1 = fault

MGS-550 Fixed Gas Detector

Reg	Description	Range
10015	Sensor 2 Saturation Overflow	0 or 1 = gas > full scale
10016	Sensor 2 Saturation Underflow	0 or 1 = gas < 0
10017	Sensor 2 Start-up	0 or 1 = start-up
10018 - 10020	<i>Reserved</i>	
10021	Relay 1 State	0 or 1 = energized
10022	Relay 2 State	0 or 1 = energized
10023	Relay 3 State	0 or 1 = energized
10024	Instrument Electronics Offline	0 or 1 = offline
10025	Instrument Electronics Non-Critical Fault	0 or 1 = fault
10026	Instrument Electronics Critical Fault	0 or 1 = fault

9.3.4 Output Status Flags

Output status flags are readable using Modbus function code 01 and writable using function code 05.

Reg	Description	Range
00001	Sensor 1 calibration expired. This flag can be cleared by performing a calibration or by resetting.	0 or 1 = need calibration
00002	Sensor 2 calibration expired. This flag can be cleared by performing a calibration or by resetting.	0 or 1 = need calibration
00003	Alarm Flag (0 or 1 = alarm) for any alarm (not fault).	0 or 1 = alarm
00004	Writing zero clears any acknowledgeable or latched alarm. This is the same behavior as holding the ENTER key for 5 seconds.	
00005	Relay closed test. Setting this flag to zero closes all 3 relays simultaneously for 5 seconds. At the end of the test the relays revert to their normal operation.	
00006	Relay opened test. Setting this flag to zero opens all 3 relays simultaneously for 5 seconds. At the end of the test the relays revert to their normal operation	
00007	Analog Output Zero Test. Setting this to one drives the analog outputs to their minimum value. This depends on the configuration of the analog output. <ul style="list-style-type: none"> For 4-20mA it will drive 4mA For all voltage ranges it will drive 0V During the test the Modbus flag will remain ON. When the test is completed the flag will turn OFF	0 or 1 = test in process

Reg	Description	Range
00008	<p>Display Test Mode. Setting this sets all 7-segment display segments, power LED and both units LEDs active simultaneously for 5 seconds. At the end the display will revert to normal operation.</p> <p>During the test the Modbus flag will remain ON. When the test is completed the flag will turn OFF. This test is only operative outside the menus.</p>	0 or 1 = test in process

SECTION 10. ORDERING INFORMATION

10.1 MGS-550 Instrument Only



NOTICE

In the descriptions below, "MGS-550 Gas Detector" includes an instrument and one sensing head mounted directly to the instrument housing. Remote or secondary local sensors must be ordered as separate items.

P/N	MGS-550 Instrument Only
6600-8000	MGS-550 Instrument ONLY, IP66 (For remote sensor applications, order sensing heads below)

10.2 MGS-550 Gas Detector, IP66 with IP66 Sensor

P/N	MGS-550 Gas Detector, IP66 with IP66 Sensor Installed at the Factory
6600-8010	MGS-550 Gas Detector, IP66, IR, CO ₂ , 0-5000 ppm
6600-8011	MGS-550 Gas Detector, IP66, IR, CO ₂ , 0-10000 ppm
6600-8012	MGS-550 Gas Detector, IP66, IR, CO ₂ , 0-20000 ppm
6600-8013	MGS-550 Gas Detector, IP66, IR, CO ₂ , 0-30000 ppm
6600-8014	MGS-550 Gas Detector, IP66, IR, CO ₂ , 0-40000 ppm
6600-8015	MGS-550 Gas Detector, IP66, IR, CO ₂ , 0-50000 ppm
6600-8016	MGS-550 Gas Detector, IP66, IR, Butane, 0-100 %LEL
6600-8017	MGS-550 Gas Detector, IP66, IR, Methane, 0-100 %LEL
6600-8018	MGS-550 Gas Detector, IP66, IR, Propane, 0-100 %LEL
6600-8019	MGS-550 Gas Detector, IP66, EC, NH ₃ , 0-100 ppm
6600-8020	MGS-550 Gas Detector, IP66, EC, NH ₃ , 0-1000 ppm
6600-8021	MGS-550 Gas Detector, IP66, EC, NH ₃ , 0-5000 ppm
6600-8023	MGS-550 Gas Detector, IP66, EC, CO, 0-1000 ppm
6600-8024	MGS-550 Gas Detector, IP66, EC, NO ₂ , 0-20 ppm
6600-8025	MGS-550 Gas Detector, IP66, EC, O ₂ , 0-30 Vol%
6600-8026	MGS-550 Gas Detector, no IP rating, EC, Cl ₂ , 0-10 ppm
6600-8027	MGS-550 Gas Detector, no IP rating, EC, F ₂ , 0-1 ppm
6600-8028	MGS-550 Gas Detector, no IP rating, EC, O ₃ , 0-1 ppm
6600-8029	MGS-550 Gas Detector, IP66, EC, SO ₂ , 0-10 ppm
6600-8030	MGS-550 Gas Detector, IP66, EC, H ₂ S, 0-200 ppm
6600-8031	MGS-550 Gas Detector, no IP rating, EC, HCl, 0-10 ppm
6600-8032	MGS-550 Gas Detector, IP66, EC, HCN, 0-30 ppm
6600-8033	MGS-550 Gas Detector, IP66, EC, H ₂ , 0-10000 ppm
6600-8034	MGS-550 Gas Detector, IP66, CT, NH ₃ , 0-100 %LEL
6600-8035	MGS-550 Gas Detector, IP66, CT, LPG, 0-100 %LEL
6600-8036	MGS-550 Gas Detector, IP66, CT, Methane, 0-100 %LEL
6600-8037	MGS-550 Gas Detector, IP66, CT, Toluene/Xylene/Jet Fuels (heavy hydrocarbons), 0-100 %LEL
6600-8038	MGS-550 Gas Detector, IP66, CT, Propane, 0-100 %LEL

P/N	MGS-550 Gas Detector, IP66 with IP66 Sensor Installed at the Factory
6600-8039	MGS-550 Gas Detector, IP66, CT, Butane, 0-100 %LEL
6600-8040	MGS-550 Gas Detector, IP66, SC, R22, 0-1000 ppm
6600-8041	MGS-550 Gas Detector, IP66, SC, R32, 0-1000 ppm
6600-8042	MGS-550 Gas Detector, IP66, SC, R134a, 0-1000 ppm
6600-8043	MGS-550 Gas Detector, IP66, SC, R404a, 0-1000 ppm
6600-8044	MGS-550 Gas Detector, IP66, SC, R407a, 0-1000 ppm
6600-8045	MGS-550 Gas Detector, IP66, SC, R407c, 0-1000 ppm
6600-8046	MGS-550 Gas Detector, IP66, SC, R407f, 0-1000 ppm
6600-8047	MGS-550 Gas Detector, IP66, SC, R410a, 0-1000 ppm
6600-8048	MGS-550 Gas Detector, IP66, SC, R422, 0-1000 ppm
6600-8049	MGS-550 Gas Detector, IP66, SC, R422d, 0-1000 ppm
6600-8050	MGS-550 Gas Detector, IP66, SC, R427a, 0-1000 ppm
6600-8051	MGS-550 Gas Detector, IP66, SC, R507, 0-1000 ppm
6600-8052	MGS-550 Gas Detector, IP66, SC, HFO1234YF, 0-1000 ppm
6600-8053	MGS-550 Gas Detector, IP66, SC, HFO1234ZE, 0-1000 ppm
6600-8054	MGS-550 Gas Detector, IP66, SC, R22, 0-10000 ppm
6600-8055	MGS-550 Gas Detector, IP66, SC, R32, 0-10000 ppm
6600-8056	MGS-550 Gas Detector, IP66, SC, R134a, 0-10000 ppm
6600-8057	MGS-550 Gas Detector, IP66, SC, R404a, 0-10000 ppm
6600-8058	MGS-550 Gas Detector, IP66, SC, R407a, 0-10000 ppm
6600-8059	MGS-550 Gas Detector, IP66, SC, R407c, 0-10000 ppm
6600-8060	MGS-550 Gas Detector, IP66, SC, R407f, 0-10000 ppm
6600-8061	MGS-550 Gas Detector, IP66, SC, R410a, 0-10000 ppm
6600-8062	MGS-550 Gas Detector, IP66, SC, R422, 0-10000 ppm
6600-8063	MGS-550 Gas Detector, IP66, SC, R422d, 0-10000 ppm
6600-8065	MGS-550 Gas Detector, IP66, SC, R507, 0-10000 ppm
6600-8067	MGS-550 Gas Detector, IP66, SC, HFO1234ZE, 0-10000 ppm
6600-8069	MGS-550 Gas Detector, IP66, SC, NH ₃ , 0-10000 ppm
6600-8070	MGS-550 Gas Detector, IP66, SC, R290, 0-5000 ppm
6600-8071	MGS-550 Gas Detector, IP66, SC, R600, 0-5000 ppm
6600-8072	MGS-550 Gas Detector, IP66, SC, H ₂ , 0-5000 ppm
6600-8073	MGS-550 Gas Detector, IP66, SC, CH ₄ , 0-5000 ppm
6600-8074	MGS-550 Gas Detector, IP66, SC, VOC/Ethanol, 0-1000 ppm
6600-8075	MGS-550 Gas Detector, IP66, SC, Ethylene, 0-2000 ppm

10.3 MGS-550 Ex d Instruments with Sensing Heads



In the descriptions below, "MGS-550 Gas Detector" includes an instrument and one sensing head mounted directly to the instrument housing. Remote or secondary local sensors must be ordered as separate items.

NOTICE

P/N	MGS-550 Ex d Instruments with Sensing Heads
6600-8500	MGS-550 Instrument ONLY, Ex d Enclosure (For remote sensor applications, order sensing heads below)

10.4 MGS-550 Gas Detector, Ex d Enclosure with Ex d Sensing Head

P/N	MGS-550 Gas Detector, Ex d Enclosure with Ex d Sensing Head Installed at the Factory
6600-8510	MGS-550 Gas Detector, Ex d, IR, CO ₂ , 0-5000 ppm
6600-8511	MGS-550 Gas Detector, Ex d, IR, CO ₂ , 0-10000 ppm
6600-8512	MGS-550 Gas Detector, Ex d, IR, CO ₂ , 0-20000 ppm
6600-8513	MGS-550 Gas Detector, Ex d, IR, CO ₂ , 0-30000 ppm
6600-8514	MGS-550 Gas Detector, Ex d, IR, CO ₂ , 0-40000 ppm
6600-8515	MGS-550 Gas Detector, Ex d, IR, CO ₂ , 0-50000 ppm
6600-8516	MGS-550 Gas Detector, Ex d, IR, Butane, 0-100 %LEL
6600-8517	MGS-550 Gas Detector, Ex d, IR, Methane, 0-100 %LEL
6600-8518	MGS-550 Gas Detector, Ex d, IR, Propane, 0-100 %LEL
6600-8519	MGS-550 Gas Detector, Ex d, EC, NH ₃ , 0-100 ppm
6600-8520	MGS-550 Gas Detector, Ex d, EC, NH ₃ , 0-1000 ppm
6600-8521	MGS-550 Gas Detector, Ex d, EC, NH ₃ , 0-5000 ppm
6600-8523	MGS-550 Gas Detector, Ex d, EC, CO, 0-1000 ppm
6600-8524	MGS-550 Gas Detector, Ex d, EC, NO ₂ , 0-20 ppm
6600-8525	MGS-550 Gas Detector, Ex d, EC, O ₂ , 0-30 Vol%
6600-8529	MGS-550 Gas Detector, Ex d, EC, SO ₂ , 0-10 ppm
6600-8530	MGS-550 Gas Detector, Ex d, EC, H ₂ S, 0-200 ppm
6600-8532	MGS-550 Gas Detector, Ex d, EC, HCN, 0-30 ppm
6600-8533	MGS-550 Gas Detector, Ex d, EC, H ₂ , 0-10000ppm
6600-8534	MGS-550 Gas Detector, Ex d, CT, NH ₃ , 0-100 %LEL
6600-8535	MGS-550 Gas Detector, Ex d, CT, LPG, 0-100 %LEL
6600-8536	MGS-550 Gas Detector, Ex d, CT, Methane, 0-100 %LEL
6600-8537	MGS-550 Gas Detector, Ex d, CT, Toluene/Xylene/Jet Fuels (heavy hydrocarbons), 0-100 %LEL
6600-8538	MGS-550 Gas Detector, Ex d, CT, Propane, 0-100 %LEL
6600-8539	MGS-550 Gas Detector, Ex d, CT, Butane, 0-100 %LEL
6600-8540	MGS-550 Gas Detector, Ex d, SC, R22, 0-1000 ppm
6600-8541	MGS-550 Gas Detector, Ex d, SC, R32, 0-1000 ppm
6600-8542	MGS-550 Gas Detector, Ex d, SC, R134a, 0-1000 ppm

P/N	MGS-550 Gas Detector, Ex d Enclosure with Ex d Sensing Head Installed at the Factory
6600-8543	MGS-550 Gas Detector, Ex d, SC, R404a, 0-1000 ppm
6600-8544	MGS-550 Gas Detector, Ex d, SC, R407a, 0-1000 ppm
6600-8545	MGS-550 Gas Detector, Ex d, SC, R407c, 0-1000 ppm
6600-8546	MGS-550 Gas Detector, Ex d, SC, R407f, 0-1000 ppm
6600-8547	MGS-550 Gas Detector, Ex d, SC, R410a, 0-1000 ppm
6600-8548	MGS-550 Gas Detector, Ex d, SC, R422, 0-1000 ppm
6600-8549	MGS-550 Gas Detector, Ex d, SC, R422d, 0-1000 ppm
6600-8550	MGS-550 Gas Detector, Ex d, SC, R427a, 0-1000 ppm
6600-8551	MGS-550 Gas Detector, Ex d, SC, R507, 0-1000 ppm
6600-8552	MGS-550 Gas Detector, Ex d, SC, HFO1234YF, 0-1000 ppm
6600-8553	MGS-550 Gas Detector, Ex d, SC, HFO1234ZE, 0-1000 ppm
6600-8554	MGS-550 Gas Detector, Ex d, SC, R22, 0-10000 ppm
6600-8555	MGS-550 Gas Detector, Ex d, SC, R32, 0-10000 ppm
6600-8556	MGS-550 Gas Detector, Ex d, SC, R134a, 0-10000 ppm
6600-8557	MGS-550 Gas Detector, Ex d, SC, R404a, 0-10000 ppm
6600-8558	MGS-550 Gas Detector, Ex d, SC, R407a, 0-10000 ppm
6600-8559	MGS-550 Gas Detector, Ex d, SC, R407c, 0-10000 ppm
6600-8560	MGS-550 Gas Detector, Ex d, SC, R407f, 0-10000 ppm
6600-8561	MGS-550 Gas Detector, Ex d, SC, R410a, 0-10000 ppm
6600-8562	MGS-550 Gas Detector, Ex d, SC, R422, 0-10000 ppm
6600-8563	MGS-550 Gas Detector, Ex d, SC, R422d, 0-10000 ppm
6600-8565	MGS-550 Gas Detector, Ex d, SC, R507, 0-10000 ppm
6600-8567	MGS-550 Gas Detector, Ex d, SC, HFO1234ZE, 0-10000 ppm
6600-8569	MGS-550 Gas Detector, Ex d, SC, NH ₃ , 0-10000 ppm
6600-8570	MGS-550 Gas Detector, Ex d, SC, R290, 0-5000 ppm
6600-8571	MGS-550 Gas Detector, Ex d, SC, R600, 0-5000 ppm
6600-8572	MGS-550 Gas Detector, Ex d, SC, H ₂ , 0-5000 ppm
6600-8573	MGS-550 Gas Detector, Ex d, SC, CH ₄ , 0-5000 ppm
6600-8574	MGS-550 Gas Detector, Ex d, SC, VOC/Ethanol, 0-1000 ppm
6600-8575	MGS-550 Gas Detector, Ex d, SC, Ethylene, 0-2000 ppm

10.5 MGS-550 5m Remote and Second Sensing Heads



Below is the MGS-550 Sensing Head Part Number Configurator. Part number format is: 6600-8ABC.

NOTICE



All 5m remote and second, directly mounted sensing heads must be ordered separately.

NOTICE

Code "A"	IP66 Sensing Head Cable Type "A" Select the Required Cable Length, Noting the "A" Code
1	IP66 Sensing Head: 5 meter cable, for remote sensor applications
6	Ex d Sensing Head: 5 meter cable, for remote sensor applications
7	Ex d Sensing Head: For mounting directly to MGS-550 instrument
8	IP66 Sensing Head: For mounting directly to MGS-550 instrument

Codes "B & C"	Sensing Head Target Gas and Range "B & C" Select the Target Gas and Range, Noting the "B & C" Codes
10	IR, CO ₂ , 0-5000 ppm
11	IR, CO ₂ , 0-10000 ppm
12	IR, CO ₂ , 0-20000 ppm
13	IR, CO ₂ , 0-30000 ppm
14	IR, CO ₂ , 0-40000 ppm
15	IR, CO ₂ , 0-50000 ppm
16	IR, Butane, 0-100 %LEL
17	IR, Methane, 0-100 %LEL
18	IR, Propane, 0-100 %LEL
19	EC, NH ₃ , 0-100 ppm
20	EC, NH ₃ , 0-1000 ppm
21	EC, NH ₃ , 0-5000 ppm
23	EC, CO, 0-1000 ppm
24	EC, NO ₂ , 0-20 ppm
25	EC, O ₂ , 0-30 Vol%
26	EC, Cl ₂ , 0-10 ppm (no IP rating, N/A in Ex d)
27	EC, F ₂ , 0-1 ppm (no IP rating, N/A in Ex d)
28	EC, O ₃ , 0-1 ppm (no IP rating, N/A in Ex d)
29	EC, SO ₂ , 0-10 ppm
30	EC, H ₂ S, 0-200 ppm
31	EC, HCl, 0-10 ppm (no IP rating, N/A in Ex d)
32	EC, HCN, 0-30 ppm

Codes "B & C"	Sensing Head Target Gas and Range "B & C" Select the Target Gas and Range, Noting the "B & C" Codes
33	EC, H ₂ , 0-10000 ppm
34	CT, NH ₃ , 0-100 %LEL
35	CT, LPG, 0-100 %LEL
36	CT, Methane, 0-100 %LEL
37	CT, Heavy hydrocarbons 0-100 %LEL
38	CT, Propane, 0-100 %LEL
39	CT, Butane, 0-100 %LEL
40	SC, R22, 0-1000 ppm
41	SC, R32, 0-1000 ppm
42	SC, R134a, 0-1000 ppm
43	SC, R404a, 0-1000 ppm
44	SC, R407a, 0-1000 ppm
45	SC, R407c, 0-1000 ppm
46	SC, R407f, 0-1000 ppm
47	SC, R410a, 0-1000 ppm
48	SC, R422, 0-1000 ppm
49	SC, R422d, 0-1000 ppm
50	SC, R427a, 0-1000 ppm
51	SC, R507, 0-1000 ppm
52	SC, HFO1234YF, 0-1000 ppm
53	SC, HFO1234ZE, 0-1000 ppm
54	SC, R22, 0-10000 ppm
55	SC, R32, 0-10000 ppm
56	SC, R134a, 0-10000 ppm
57	SC, R404a, 0-10000 ppm
58	SC, R407a, 0-10000 ppm
59	SC, R407c, 0-10000 ppm
60	SC, R407f, 0-10000 ppm
61	SC, R410a, 0-10000 ppm
62	SC, R422, 0-10000 ppm
63	SC, R422d, 0-10000 ppm
65	SC, R507, 0-10000 ppm
67	SC, HFO1234ZE, 0-10000 ppm
69	SC, NH ₃ , 0-10000 ppm
70	SC, R290, 0-5000 ppm
71	SC, R600, 0-5000 ppm
72	SC, H ₂ , 0-5000 ppm
73	SC, CH ₄ , 0-5000 ppm
74	SC, VOC/Ethanol, 0-1000 ppm
75	SC, Ethylene 0-2000 ppm

10.6 MGS-550 Replacement Parts and Accessories

P/N	MGS-550 Replacement Parts and Accessories																			
6600-8400	Replacement interface I/O PCB Assembly, MGS-550 GP. Base PCB with terminal blocks for IP66 housing.																			
6600-8401	Replacement interface I/O PCB Assembly, MGS-550 XP. Base PCB with terminal blocks for Ex d housing.																			
6600-8402	Replacement display PCB Assembly, MGS-550 GP/XP																			
6600-8403	Ribbon Cable, MGS-550 GP/XP. Connects top and bottom PCBs																			
6600-8404	Accessory Kit, MGS-550 GP. Includes spare cable glands and blanking plugs, gaskets.																			
6600-8405	Sensing Head Common Control PCBA, MGS-550 GP/XP																			
6600-8406	<p>Sensing Head Front End Kit, MGS-550 GP, IP66. Includes lock nut, nosepiece with membrane, O-ring, sensor foam spacers, and splash guard with calibration port. Also included are gaskets to be used as follows.</p> <table border="1" data-bbox="451 688 1360 947"> <thead> <tr> <th data-bbox="451 688 610 747">Gasket P/N</th> <th data-bbox="610 688 764 747">Gasket Thickness</th> <th data-bbox="764 688 906 747">Sensor Type</th> <th data-bbox="906 688 1360 747">Applicable Sensor(s)</th> </tr> </thead> <tbody> <tr> <td data-bbox="451 747 610 858">1100-0031</td> <td data-bbox="610 747 764 858" rowspan="2">9.5 mm</td> <td data-bbox="764 747 906 787">EC</td> <td data-bbox="906 747 1360 787">CO, O₂, SO₂</td> </tr> <tr> <td data-bbox="451 787 610 858"></td> <td data-bbox="764 787 906 858">CT</td> <td data-bbox="906 787 1360 858">NH₃, LPG, Methane, Propane, Butane, Toluene/Xylene/Jet Fuels</td> </tr> <tr> <td data-bbox="451 858 610 905">1100-0542</td> <td data-bbox="610 858 764 905">6.35 mm</td> <td data-bbox="764 858 906 905">IR</td> <td data-bbox="906 858 1360 905">CO₂</td> </tr> <tr> <td data-bbox="451 905 610 947">1100-0030</td> <td data-bbox="610 905 764 947">6.5 mm</td> <td data-bbox="764 905 906 947">EC, SC</td> <td data-bbox="906 905 1360 947">All other sensors</td> </tr> </tbody> </table>	Gasket P/N	Gasket Thickness	Sensor Type	Applicable Sensor(s)	1100-0031	9.5 mm	EC	CO, O ₂ , SO ₂		CT	NH ₃ , LPG, Methane, Propane, Butane, Toluene/Xylene/Jet Fuels	1100-0542	6.35 mm	IR	CO ₂	1100-0030	6.5 mm	EC, SC	All other sensors
Gasket P/N	Gasket Thickness	Sensor Type	Applicable Sensor(s)																	
1100-0031	9.5 mm	EC	CO, O ₂ , SO ₂																	
		CT	NH ₃ , LPG, Methane, Propane, Butane, Toluene/Xylene/Jet Fuels																	
1100-0542	6.35 mm	IR	CO ₂																	
1100-0030	6.5 mm	EC, SC	All other sensors																	
6600-8407	Sensing Head Front End Kit, MGS-550 GP, No IP Rating. Includes lock nut, nosepiece without membrane, o-ring, gasket, sensor foam spacers, splash guard with calibration port. For Cl ₂ , F ₂ , HCl and O ₃ instruments.																			

SECTION 11. DECLARATION OF CONFORMITY

CE DECLARATION OF CONFORMITY

The manufacturer of the products covered by this declaration:	Murco Ltd., Trading as Bacharach, Inc. 114a George's Street Lower Dun Laoghaire Ireland
Year(s) conformity is declared:	2015
Product(s):	Gas Detector
Model(s):	06-15A

The undersigned hereby declares that the above referenced product(s) are in conformity with the provisions of the following standards and are in accordance with the following directives.

Standard(s):

IEC 61010-1:2010, 3rd Edition EN 61010-1:2010, 3rd Edition UL 61010-1, 3rd Edition CSA C22.2 No 61010-1, 3rd Edition	Safety Standards	Electrical Equipment for Measurement, Control, and Laboratory Use; Part 1: General Requirements
EN 50270:2006	Electromagnetic Compatibility (EMC) Standards	Electrical Apparatus for the Detection and Measurement of Combustible Gases, Toxic Gases, or Oxygen
EN 55011:2009 +A1:2010	Radio Disturbance Characteristics	Limits and Methods of Measurements for Industrial, Scientific and Medical (ISM) Radio-Frequency Equipment

Directive(s):

2004/108/EC	Electromagnetic Compatibility Directive
2006/95/EC	Low Voltage Directive

Signature: _____



Name: Philip Hassell
Title: Engineering Manager
Date: 13 May 2015

The technical documentation file required by this directive is maintained at the corporate headquarters of Murco Ltd.



World Headquarters

621 Hunt Valley Circle, New Kensington, Pennsylvania 15068

Phone: 724-334-5000 • Toll Free: 1-800-736-4666 • Fax: 724-334-5001

Website: www.MyBacharach.com • E-mail: help@MyBacharach.com



USA



Europe